

MIPRO[®] MA-505

Portability

Simplicity

Flexibility

PORTABLE WIRELESS PA SYSTEM

User Guide



MIPRO[®]
MICROPHONE PROFESSIONALS

MIPRO Electronics Co., Ltd

Headquarters : 814 Pei-Kang Road, Chiayi, 60096, Taiwan
Tel : +886.5.238.0809 Fax : +886.5.238.0803
www.mipro.com.tw mipro@mipro.com.tw

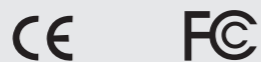

All rights reserved. MN015/04

Do not copy or forward without prior approvals MIPRO.

Specifications and design subject to change without notice.

IMPORTANT SAFETY INSTRUCTIONS

1. Read these instructions.
2. Keep these instructions.
3. Heed all warnings.
4. Follow all instructions.
5. Do not use this apparatus near water.
6. Clean only with a dry cloth.
7. Do not block any ventilation openings. Install in accordance with the manufacturer's instructions.
8. Do not install near any heat sources such as radiators, heat registers, stoves, or other apparatus (including amplifiers) that produce heat.
9. Do not defeat the safety purpose of the polarised or ground plug: A polarised plug has two blades with one wider than the other. The wide blade is provided for your safety. When the provided plug does not fit into your outlet, consult an electrician for replacement of the obsolete outlet.
10. Protect the power cord from being walked on or pinched particularly at plug, convenience receptacles, and the point where they exit from the apparatus.
11. Only use attachments/accessories specified by the manufacturer.
12. Use only with a cart, stand, tripod, bracket, or table specified by the manufacturer, or sold with the apparatus. When a cart is used, use caution when moving the cart/apparatus combination to avoid injury from tip-over.
13. Unplug this apparatus during lightning storms or when unused for long periods of time.
14. Refer all servicing to qualified service personnel. Servicing is required when the apparatus has been damaged in any way, such as power-supply cord or plug is damaged, liquid has been spilled or objects have fallen into the apparatus, the apparatus has been exposed to rain or moisture, does not operate normally, or has been dropped.
15. To reduce the risk of fire or electric shock, do not expose this apparatus to rain or moisture.
16. Apparatus should not be exposed to dripping or splashing and no objects filled with liquids, should be placed on the apparatus.
17. Use only with the battery which specified by manufacturer.
18. The power supply cord set is to be the mains disconnected device.
19. Batter Pack shall not be exposed to excessive heat such as sunshine, fire or the like.
20. In Finland, Norway and Sweden, CLASS I apparatus which is intended for connection to the building installation wiring via a plug or an appliance coupler, have a marking stating that the apparatus must be connected to an earthed MAINS socket-outlet.
21. A warning that an apparatus with CLASS I construction shall be connected to a MAINS socket outlet with a protective earthing connection.



WARNING

1. **FOR OUTDOOR USE:**
To reduce the risk of fire or electric shock, do not expose this apparatus to rain or moisture.
2. **UNDER WET LOCATION:**
Apparatus should not be exposed to dripping or splashing and no objects filled with liquids, such as vases should be placed on the apparatus.
3. **SERVICE INSTRUCTIONS:**
CAUTION - These servicing instructions are for use by qualified service personnel only. To reduce the risk of electric shock, do not perform any servicing other than that contained in the operating instructions unless you are qualified to do so.

CAUTION
RISK OF ELECTRIC SHOCK
DO NOT OPEN

This symbol indicates that dangerous voltage constituting a risk of electric shock is present within this unit.

This symbol indicates that there are important operating and maintenance instructions in the literature accompanying this unit.

FC & IC - ID

THIS DEVICE COMPLIES WITH PART15 OF THE FCC RULES AND RSS-123 ISSUE2 OF CANADA. OPERATION IS SUBJECT TO THE FOLLOWING TWO CONDITIONS:

- (1) This device may not cause interference.
- (2) This device must accept any interference, including interference that may cause undesired operation of the device. This equipment complies with FCC RF radiation exposure limits set forth for an uncontrolled environment.

"This product can only be used at the area that the altitude is lower than 2000m for safety purpose."

"This product can be used in non-tropical locations only for safety purpose."

Disposal



2005-08-13

Dispose of any unusable devices or batteries responsibly and in accordance with any applicable regulations.

Disposing of used batteries with domestic waste is to be avoided!

Batteries/NiCad cells often contain heavy metals such as cadmium(Cd), mercury(Hg) and lead(Pb) that makes them unsuitable for disposal with domestic waste. You may return spent batteries/accumulators free of charge to recycling centres or anywhere else batteries/accumulators are sold.

By doing so, you contribute to the conservation of our environment!

Federal Communication Commission Interference Statement

This equipment has been tested and found to comply with the limits for a Class B digital device, pursuant to Part 15 of the FCC Rules. These limits are designed to provide reasonable protection against harmful interference in a residential installation.

This equipment generates, uses and can radiate radio frequency energy and, if not installed and used in accordance with the instructions, may cause harmful interference to radio communications. However, there is no guarantee that interference will not occur in a particular installation. If this equipment does cause harmful interference to radio or television reception, which can be determined by turning the equipment off and on, the user is encouraged to try to correct the interference by one of the following measures:

- Reorient or relocate the receiving antenna.
- Increase the separation between the equipment and receiver.
- Connect the equipment into an outlet on a circuit different from that to which the receiver is connected.
- Consult the dealer or an experienced radio/TV technician for help.

FCC Caution: To assure continued compliance, any changes or modifications not expressly approved by the party responsible for compliance could void the user's authority to operate this equipment. (Example - use only shielded interface cables when connecting to computer or peripheral devices).

FCC Radiation Exposure Statement

This equipment complies with FCC RF radiation exposure limits set forth for an uncontrolled environment. This equipment should be installed and operated with a minimum distance of 20 centimeters between the radiator and your body.

This transmitter must not be co-located or operating in conjunction with any other antenna or transmitter.

The antennas used for this transmitter must be installed to provide a separation distance of at least 20 cm from all persons and must not be co-located or operating in conjunction with any other antenna or transmitter.

THIS DEVICE COMPLIES WITH PART 74 AND PART 15 OF THE FCC RULES. This equipment complies with FCC RF radiation exposure limits set forth for an uncontrolled environment.

This device complies with Industry Canada licence-exempt RSS-123 ISSUE 2 and RSS-210 ISSUE 8 standard. Operation is subject to the following two conditions: (1) this device may not cause interference, and (2) this device must accept any interference, including interference that may cause undesired operation of the device.

CONTENTS

CONTROLS AND INDICATORS	01
CONTROL PANEL	04
PAIRING BLUETOOTH MUSIC RECEIVER	06
OPERATING INSTRUCTIONS	07
CONNECTION FOR EXTERNAL AUDIO SOURCES	09
POWER USAGE INSTRUCTION	10
REPLACING RECHARGEABLE BATTERIES	12
MRM-70B: UHF DIVERSITY RECEIVER MODULE	13
WIRELESS TRANSMITTER MODULE	14
DPM-3 DIGITAL AUDIO RECORDER MODULE	15
INSTALLATION OF MIPRO CD/MP3 PLAYER	25
HELPFUL OPERATING TIPS	26
TROUBLESHOOTING-PORTABLE PUBLIC ADDRESS	27
TROUBLESHOOTING-WIRELESS MICROPHONE SYSTEMS	28
FAQ - PORTABLE PA	29
FAQ - RECHARGEABLE BATTERY	30
RECHARGEABLE BATTERY GUIDE	31
OPTIONAL MA-505 ACCESSORIES	32

CONTROLS AND INDICATORS

Front Panel

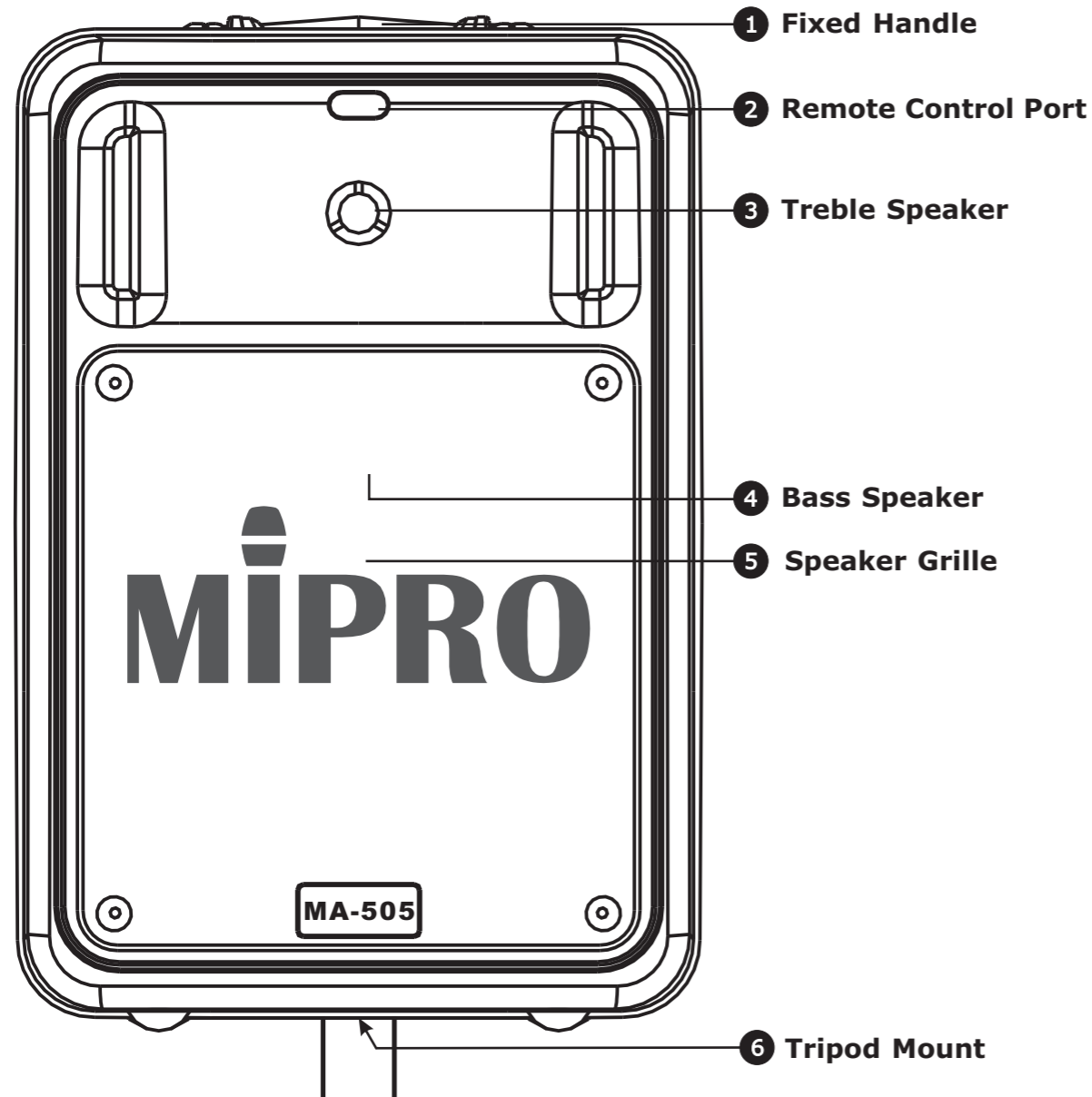

- 1 **Fixed Handle:** For balanced, easy hand carrying.
- 2 **Remote Control Port:** Aim external remote control from the front to remotely control the digital music player.
- 3 **Treble Speaker:** 1" Titanium Compression Driver.
- 4 **Bass Speaker:** 8" speaker.
- 5 **Speaker Grille:** To protect the internal speaker.
- 6 **Tripod Mount (Optional):** There is a tripod mating socket mounted in the base of the MA-505 to accommodate a 35mm tripod stand.

Rear Panel

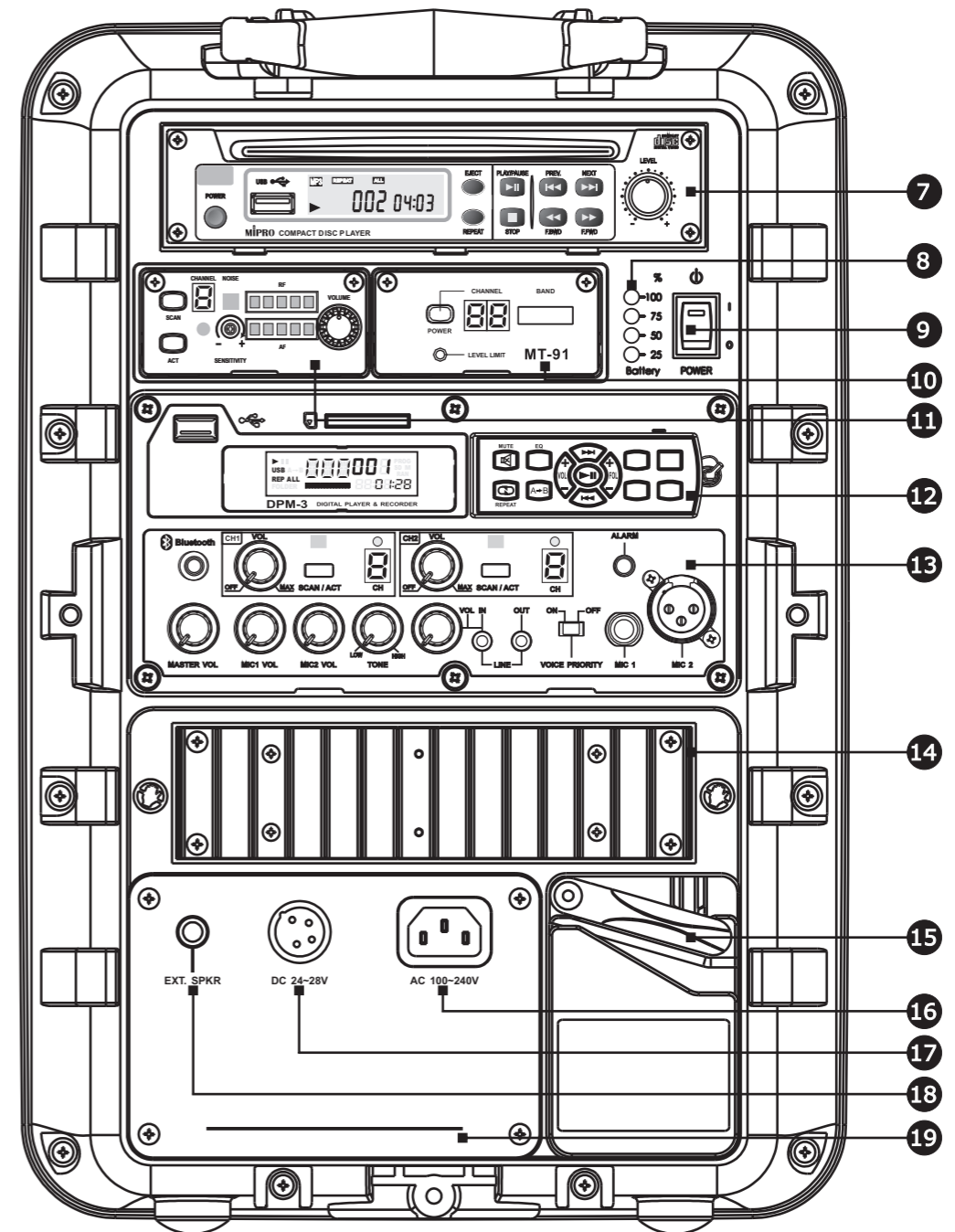

- 7 **Skip-free CD/MP3 PLAYER** (Optional)
- 8 **Battery Meter:** Displays current & charging battery level. Blinking (charging in progress); Illuminated (battery is fully charged)
- 9 **Master Power Switch:** Turns AC/DC power on/off to the unit. The indicator glows when you turn the power On. To avoid over-discharging or stressing of the built-in battery supply, it is recommended that you plug-in and charge the unit immediately when LED indicator flashes (denotes lower battery status). Otherwise, the unit will turn off automatically once a pre determined low charge level is reached as it may interrupt the performances. A full recharge may take up to 4 hours. When fully charged, make sure to turn the power OFF to conserve battery power and when not being used.
- 10 **MT-91 Wireless Transmitter Module** (Optional)
- 11 **MRM-70B Receiver Modules** (Optional)
- 12 **DPM-3 Digital Audio Recorder Module**
- 13 **Control Panel**
- 14 **Heat Sink:** Built in heat sink for amplifier. Keep the unit well ventilated when in use and please do not touch the heat sink when in operation.
- 15 **Storage Lever:** Adjust lever to keep storage lid tightly.
- 16 **AC Power Input Socket (AC 100~240V):** Input socket for AC Power (100~240V). (Various outlets fitting the standards of various countries are available for this unit. Standard Taiwan Voltage: 110V)
- 17 **DC Input Jack (DC 24~28V):** Requires external DC 24~28Volts.
- 18 **Extension Speaker Input Jack (EXT. SPKR):** Accepts output from the EXT. SPKR Jack of MA-505.
- 19 **Battery Cover:** Protects the rechargeable battery.

CONTROL PANEL

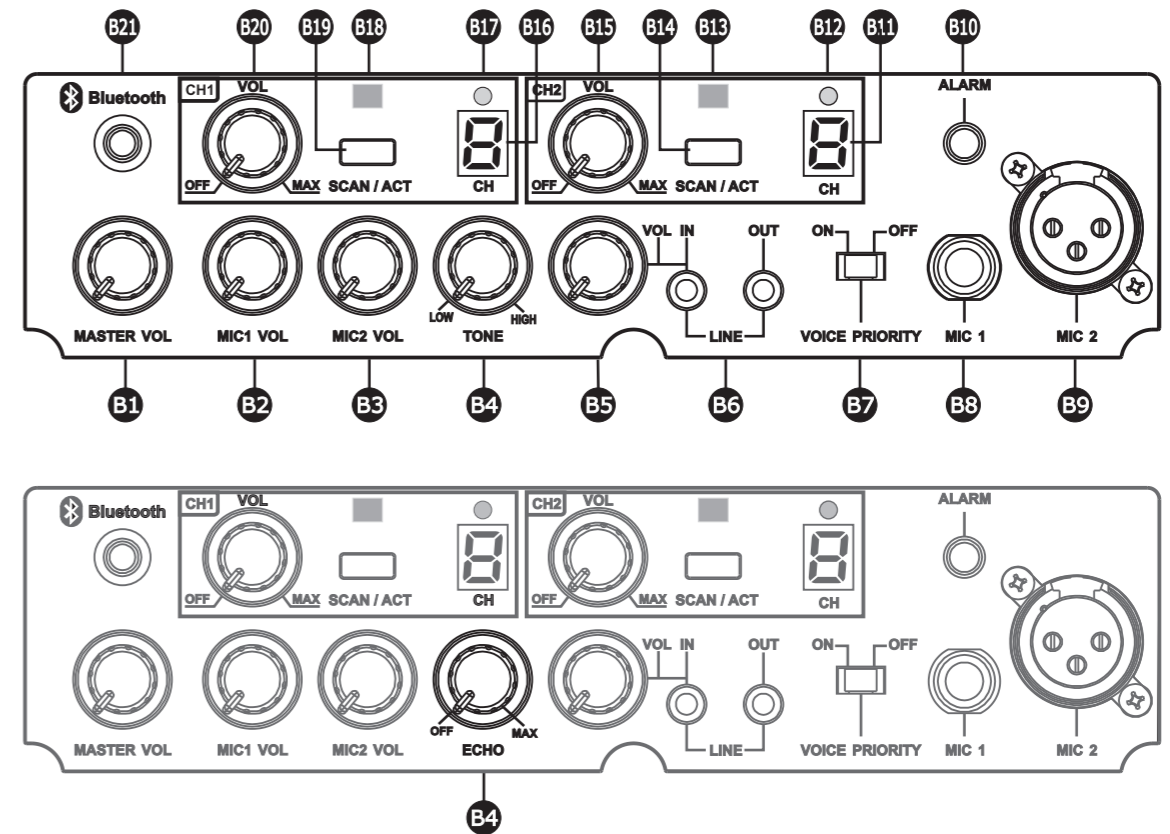

- B1 **MASTER Volume Control:** Adjust the volume of all mixed audio inputs.
- B2 **MIC 1 Volume Control:** Control the volume of the Mic 1 wired microphone.
- B3 **MIC 2 Volume Control:** Control the volume of the Mic 2 wired microphone.
- B4 **TONE Control (varies by region):** Turn counterclockwise to increase bass or turn clockwise to increase treble. Positioned at 12 o'clock for a flat response.
ECHO Control (varies by region): Adjust for desired ECHO effects. (chose one of two)
- B5 **LINE IN Volume Control:** Controls the volume of the Line Socket.
- B6 **LINE IN Socket (3.5mm mono):** Allows you use an external device with unbalanced audio output signal as an input to the MA-505.
LINE OUT Socket (3.5mm mono): Line level output. Allows you to use the MA-505 as a program input source for some other audio device.
- B7 **Voice Priority Switch:** Voice over music priority function. (factory preset: Off)
- B8 **Wired Microphone Input Socket (6.3mm/ 1/4" Unbalanced):** Allows you to use an unbalanced, wired microphone as an input source.
- B9 **Wired Microphone Input Socket (XLR Balanced):** Allows you to use wired microphone with a balanced XLR connector as an input source.

- B10 Alarm Siren Button:** Provide warning of approaching or presence of threats or situations requiring immediate attention.
- B11 CH2 Channel Screen**
- B12 CH2 RF indicator:** Glows green indicates a RF link from transmitter to receiver.
- B13 CH2 Sync port:** Uploads infrared signal to transmitter.
- B14 SCAN/ACT CH2:** Scans for an interference-free frequency & Synchronizes the receiver and transmitter frequencies.
- B15 CH2 VOL:** Powers receiver on/off and wireless CH2 volume.
- B16 CH1 Channel Screen**
- B17 CH1 RF indicator:** Glows green indicates a RF link from transmitter to receiver.
- B18 CH1 Sync port:** Uploads infrared signal to transmitter.
- B19 SCAN/ACT CH1:** Scans for an interference-free frequency & Synchronizes the receiver and transmitter frequencies.
- B20 CH1 VOL:** Powers receiver on/off and wireless CH1 volume.
- B21 Bluetooth Power Button & Indicator:** The built-in Bluetooth music receiver lets you connect a Bluetooth-enabled wireless device such as an iPod, iPhone, iPad or other smart phones, tablets, media players and play music wirelessly through this portable PA system.

PAIRING BLUETOOTH MUSIC RECEIVER

- Make sure the built-in Bluetooth music receiver is powered on and bring the wireless device within reception range.
- To power on the Bluetooth music receiver and ready for pairing, press & hold the power button for 3-5 seconds until blue/red indicator light is flashing intermittently.
- The blue/red flashing will flash intermittently to indicate the unit is powered and is now ready to be paired to your Bluetooth smart wireless device. However, if blue/red is not flashing intermittently this indicates the unit is not powered and is not ready to be paired.
- Navigate to the Bluetooth Manager on the wireless device. Locate and enable the Bluetooth feature.
- Search Bluetooth devices for the music receiver's ID. The device ID is the word 'MIPRO MB-XX' and followed by two numbers for the two XXs. Click on the device ID.
- Enter "0000" when you're prompted to enter a PIN number. This will cause your wireless device to pair with the music receiver.
- Once paired and connection is made, the blue color indicator light on the music player will continue to flash intermittently.
- Reconnect to music receiver after moving your wireless device out of its range, lost signal, objects are blocking the Bluetooth signal or after turning off the Bluetooth feature on your wireless device. Navigate to the Bluetooth Manager, and click on the correct device ID. You won't be prompted to enter the PIN number, 0000, again.
- Pair another wireless device. Navigate to the Bluetooth Manager on the currently-connected device and disable the Bluetooth function. Follow the Pairing on the new Bluetooth device to connect the new device.
- To power off the Bluetooth music receiver, press & hold the power button for 3-5 seconds until blue/red indicator light is turned off and no longer flashing intermittently.

PAIRING BLUETOOTH MUSIC RECEIVER

Tips & Warning

- After pairing, some devices will connect immediately. Others will ask you if you want to connect.
- If you move the wireless device out of the Music Receiver's range, the connection will be lost and the indicator light will go off. If you move the wireless device back into range, the connection will re-establish itself.
- The Bluetooth music player can only play music from one device at a time.
- Clean only with a dry cloth.
- Do not expose the device to rain, use it near water or in damp or wet conditions, or place containers on it containing liquids which might spill into any openings.

OPERATING INSTRUCTIONS

Wireless Mic System

- Turn on master **Power** switch. **Power** indicator glows red. Ready for operation.
- Turn on **CH1 VOL** or **CH2 VOL** switch.
- Turn transmitter power on. Ensure fresh *alkaline* or *lithium* batteries (not included) are installed.
- **CH1 RF** indicator or **CH2 RF** indicator glows green after the transmitter is turned on to denote a successful RF link.
- Adjust **CH1 VOL** or **CH2 VOL** to desired volume.
- Ensure receiver and transmitter have the same matching operating channels.

Notes:

1. Same wireless microphone can transmit to multiple MA-505 systems on the same channel for a wider and expanded coverage.
2. It is not possible to transmit two wireless microphones on the same channel to MA-505 system. Only one transmitter can be used at a time on that channel. Be sure to turn off one of the two transmitters to avoid interference.

OPERATING INSTRUCTIONS

Wired Microphone

- Plug optional MIPRO MM-107 wired dynamic microphone with a 6.3mm (1/4") connector to **MIC IN**.
- Turn on master **POWER** and adjust to desired volume.

Line Input

- Available to connect an external CD, MP3, iPod or cassette player.
- Connect a 3.5mm(mono)-to-3.5mm(stereo) audio cable (not included) to the **LINE-IN** jack.
- Turn on master **POWER**.
- Adjust **LINE VOL** to desired volume.

Alarm Siren

- Press **Alarm** button for warnings of approaching or presence of threats or situations requiring immediate attention. This is an ascending sound of an alarm.
- Alarm will sound only when master Power is powered on and one of below function is powered on.
 1. Wireless transmitter and CH1 or CH2 are powered on.
 2. Wired microphone is plugged into the Mic input and powered on.
 3. USB player is powered on & music is playing.

CONNECTION FOR EXTERNAL AUDIO SOURCES

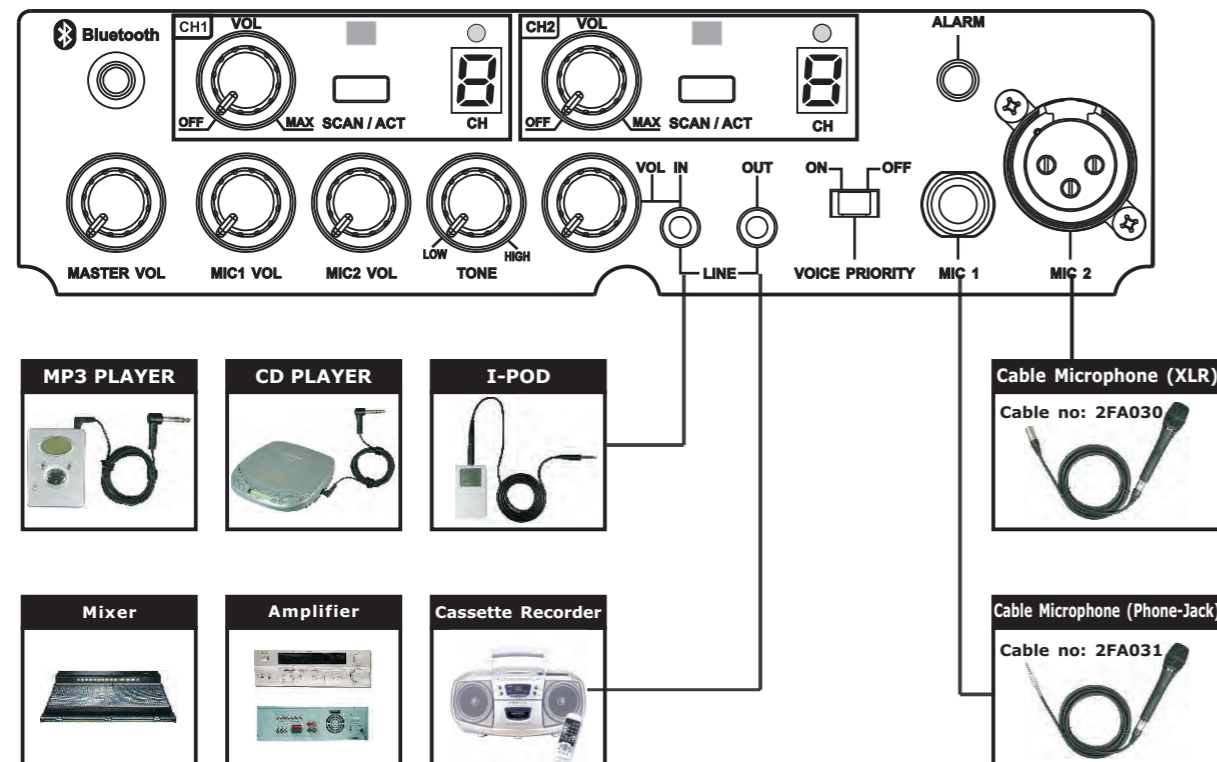

POWER USAGE INSTRUCTION

General Summary

- A built-in switching power supply allows for AC power inputs ranging from 100~240 volt and an external 24~28 volt DC power supply, is required.
- A built-in AC power supply powers the unit itself and provides recharging to the built-in rechargeable batteries, too.

How to use AC power input

- After putting the power plug into the AC input socket of the device, the 4 battery meter indicators will glow immediately, no matter if the power switch is on or off. This means that the built-in switching power supply is functioning normally and the built-in rechargeable batteries are fully charged. If the battery meter indicators are blinking this means that the built-in switching power supply is working normally and the built-in rechargeable batteries are in an under charged condition. After a couple of minutes, the battery meter indicators will stop blinking and continue a glowing condition, indicating the batteries are now fully charged.
- AC power provides power to both the unit itself and to the built-in rechargeable batteries.
- When using the AC power, you can remove or plug the power cord freely with no need to turn off the power switch first. If or when an unfortunate power cut happens during usage, the unit will activate the DC power automatically to maintain continuous operation.

How to use DC power input

- Built-in rechargeable batteries are used. When the batteries are fully charged, the unit can be operated for approximately 8 hours in standby mode. Playing the music loudly will drain the rechargeable batteries down faster. (The above figures are references for brand new, fresh batteries only)
- The built-in rechargeable batteries can be recharged when the unit is plugged into an AC or DC power outlet.
- The red power indicator will glow when power switch is turned on. Additionally, 2 to 4 battery meter indicators are glowing to indicate normal operation mode.
- If only 1 battery meter indicator is glowing this indicates low battery status therefore, it is highly recommended to plug-in for recharging and it can be operated while charging.
- If no battery meter indicator is glowing after the unit is turned on, it indicates the batteries are completely discharged or possibly faulty batteries.

- Always store the system with the batteries fully charged if needing to store the system for more than 3 months. Leave the system plugged into an AC power outlet when not in use or recharge once at least every 3 months.
- The rechargeable batteries will not function properly if not recharged for an extended period of time. It is therefore, recommended to recharge after every use regardless of the usage time to preserve battery life.

⚠ AC power and DC power can not be used at the same time.

A connector is included which allows users to make DC wiring. See diagram below for illustration:

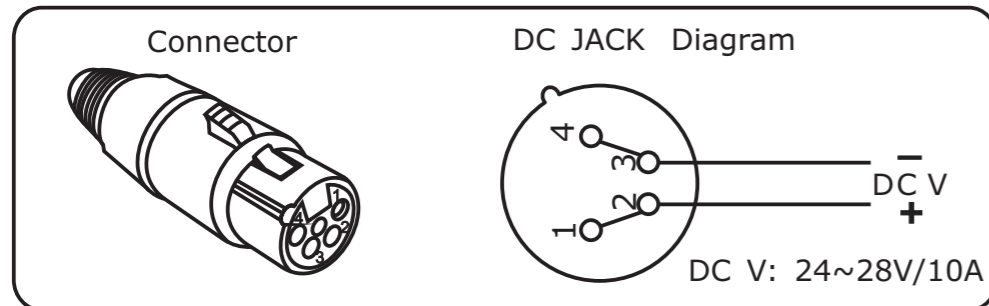

Storing Power Plug & Cable

- Adjust lever to remove the lid plate (Figure 1-1)
- Insert into the storage (Figure 1-2)
- Adjust lever to close the lid plate tightly (Figure 1-3)

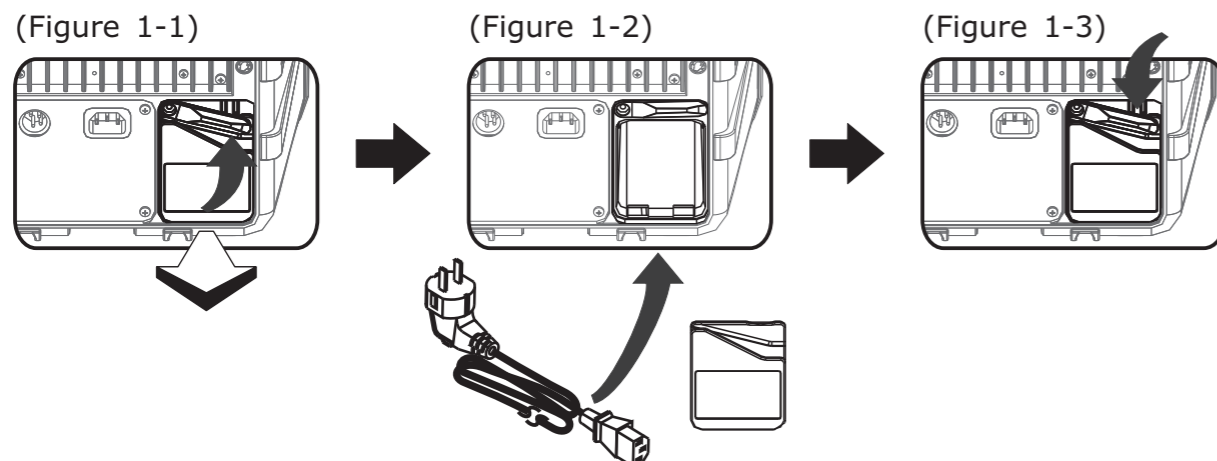

REPLACING RECHARGEABLE BATTERIES

- The batteries must be replaced every 2~3 years depending on usage over time and limited amount of charge cycles.
- Ascertain the power switch is turned off and AC cord is unplugged.
 1. Using a Phillips-head screwdriver (not supplied) remove the screws.(Figure 2-1)
 2. Remove the battery protection cover panel. (Figure 2-2)
 3. To remove batteries, gently detach and slide the battery away from the battery housing compartment horizontally. (Figure 2-3)
 4. Replace batteries "as above" and re-connect the wires to the new batteries horizontally in accordance to the wiring diagram below. (Figure 2-4)
 5. Replace the battery protection cover panel, tighten up the screws. (Figure 2-5)

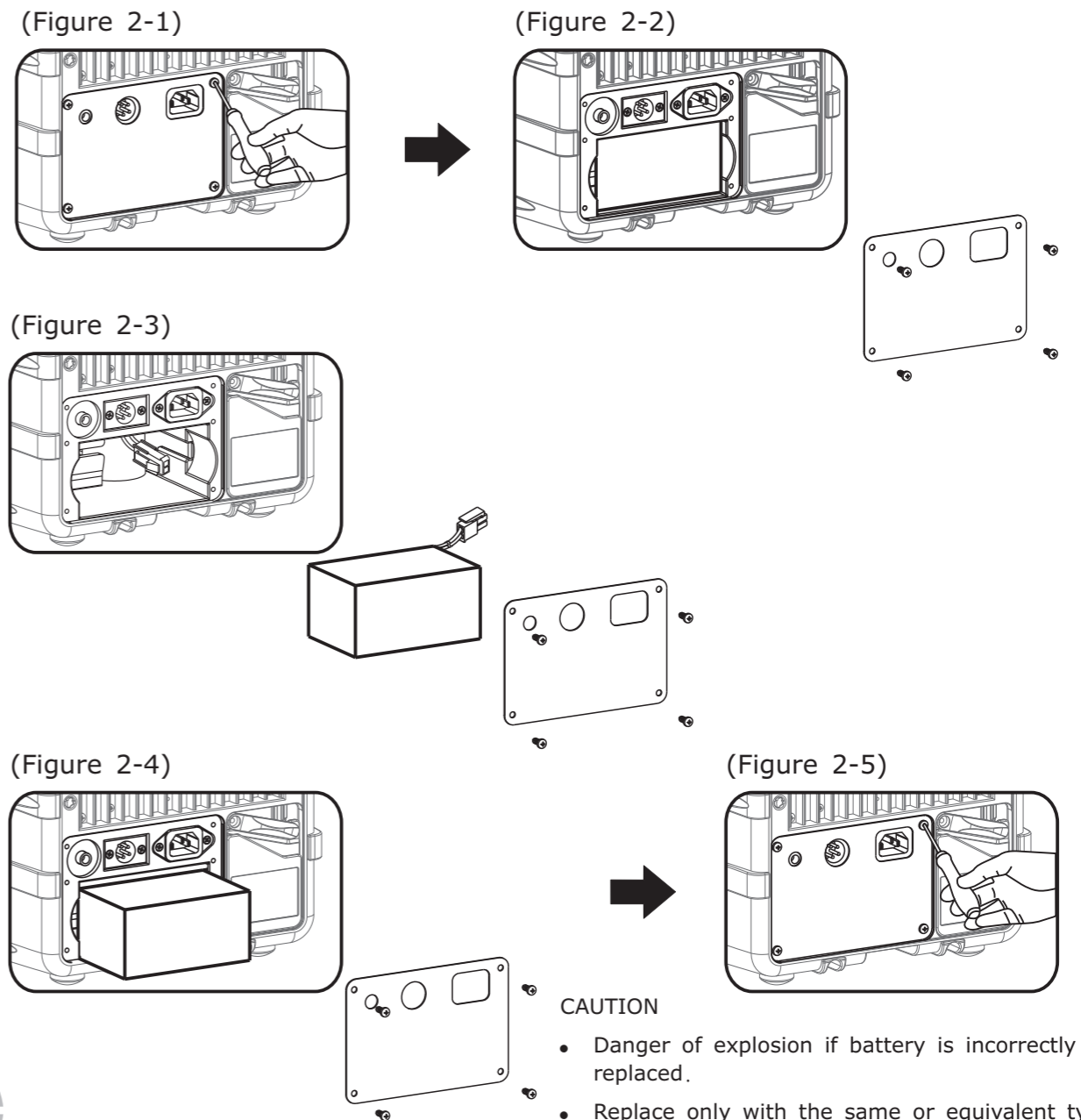

CAUTION

- Danger of explosion if battery is incorrectly replaced.
- Replace only with the same or equivalent type.

MRM-70B: UHF DIVERSITY RECEIVER MODULE

MIPRO offers an optional industry-leading diversity wireless receiver module. Up to 2 receiver modules can be installed quickly and easily for wireless microphone operation. Each receiver module has 16 preset UHF frequencies. Simply press the "scan" button once to quickly autoscan for an interference-free receiver frequency. A built-in "noise" interference indicator (when lit) detects the presence of interference. Once lit during operation simply press scan button to autoscan for another interference-free frequency.

INSTALLING MRM-70B DIVERSITY RECEIVER MODULE

Up to 2 MRM-70B receivers can be installed or 01 MRM-70B or 1 MT-91 interlinking transmitter can be installed.

1. Power off the system first.
2. Remove the 2 screws. (Figure 3-1)
3. Remove the front blank plate. (Figure 3-2)
4. Insert the receiver module. (Figure 3-3)
5. Push in and align the edge connectors firmly and tightly. (Figure 3-4)
6. Fasten the screws tightly. (Figure 3-5)

(Figure 3-1)

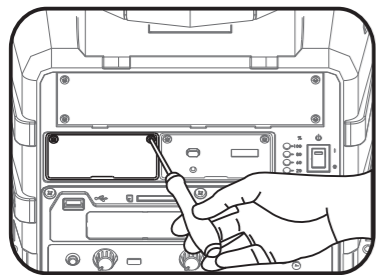

(Figure 3-2)

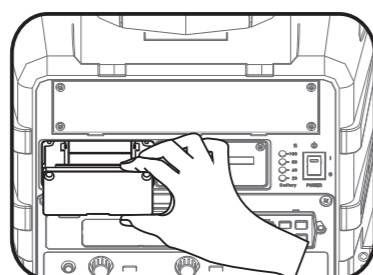

(Figure 3-3)

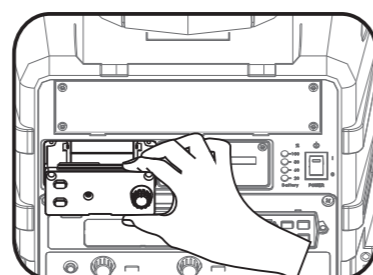

(Figure 3-4)

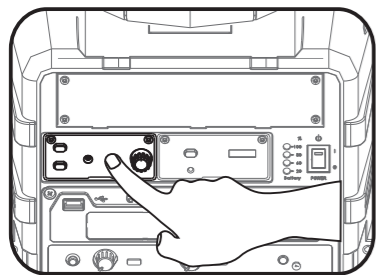

(Figure 3-5)

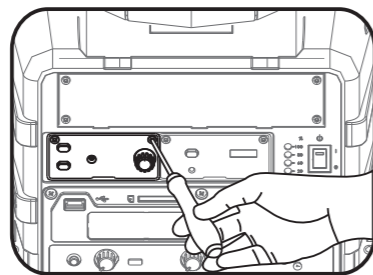

WIRELESS TRANSMITTER MODULE

INSTALLATION OF WIRELESS INTERLINKING TRANSMITTER

1. Remove screws from blank panel. (Figure 4-1)
2. Remove blank panel. (Figure 4-2)
3. Insert the Interlinking Transmitter module horizontally. (Figure 4-3)
4. Gently push in until it is aligned into place. (Figure 4-4)
5. Tighten the screws. (Figure 4-5)

(Figure 4-1)

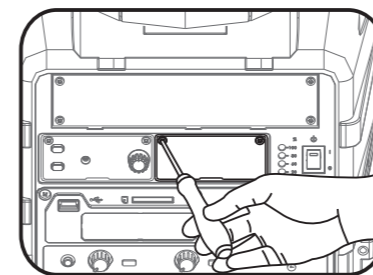

(Figure 4-2)

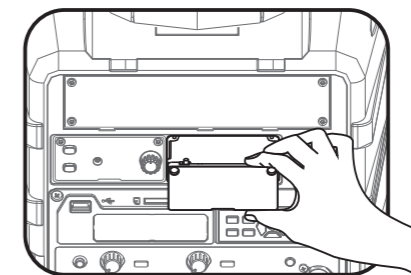

(Figure 4-3)

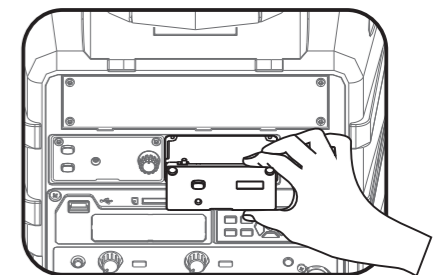

(Figure 4-4)

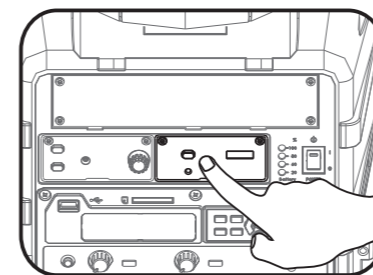

(Figure 4-5)

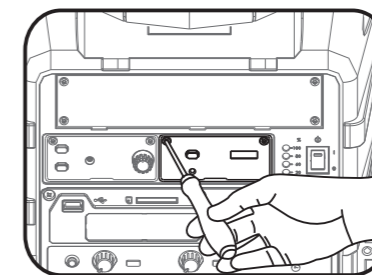

Operating Tips

1. The transmitter functions when the module and antenna are inserted properly and powered on. Ascertain the frequency code sticker is the same between the transmitter and receiver.
2. Select another module with a different frequency code if the existing operating frequency experiences continuous interference.
3. MT-91 module is available in frequency codes between 620~934MHz and compatible with MIPRO wireless receivers or portable PA amplifiers with the same frequency codes.

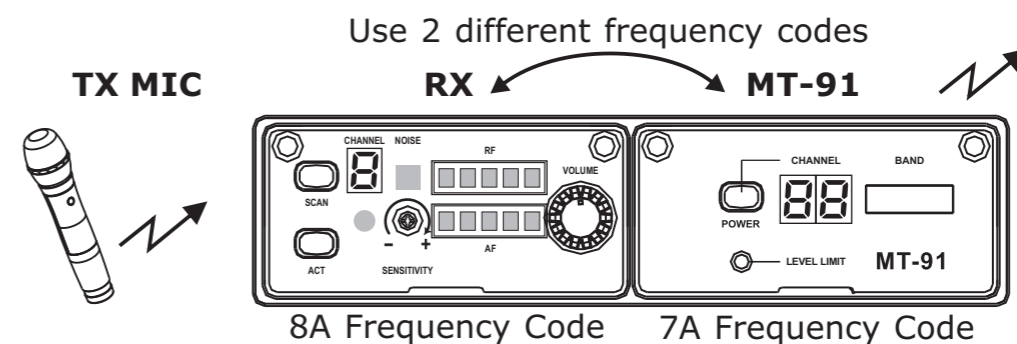

DPM-3 DIGITAL AUDIO RECORDER MODULE

Control and Indicators

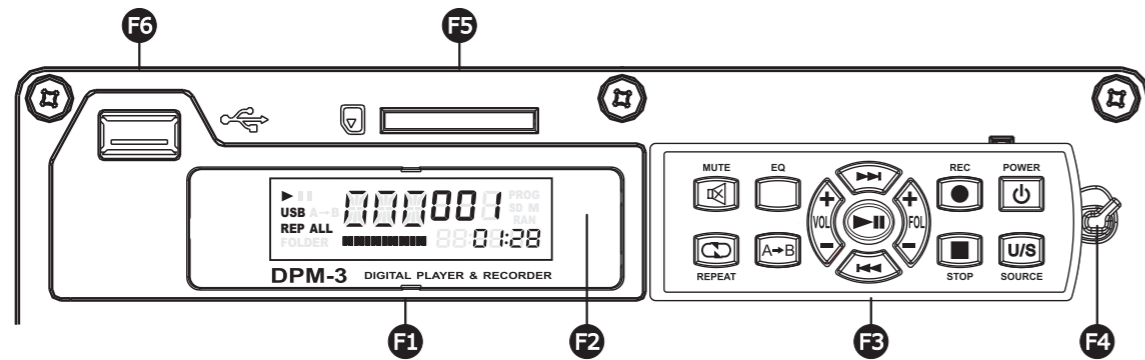

- F1 VFD DISPLAY SCREEN:** Displays parameters such as elapsed time, tracks, repeat... etc.
- F2 IR (Infrared) RECEIVER SENSOR WINDOW:** Aim towards this section to maximize signal reception quality when using the detachable Remote Control.
- F3 ON-BOARD CONTROL PANEL & REMOTE CONTROL (Detachable):** Sets functions with Control Panel or wirelessly via Remote Control.
- F4 REMOTE CONTROL LATCH:** Turn latch to the right to release the Remote Control.
- F5 SD CARD SLOT:** Supports SD/SDHC memory card and up to 32GB capacity. Insert a SD memory card (labeled side left) and push into the slot.
- F6 USB PORT:** Supports MP3, WAV and WMA format music and audio files.

Reading the Display Screen

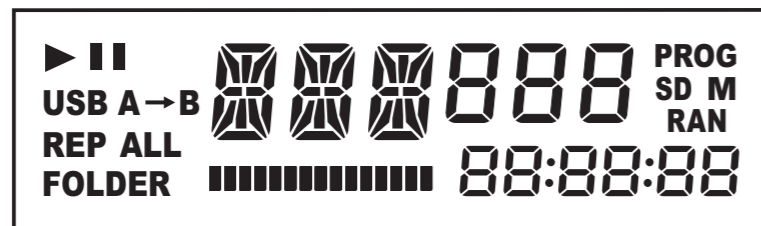

- | | | | |
|-------------------|---------------------------------|-----------------|--------------------|
| ▶ Play | : Current track playing | | : Folder Display |
| ⏸ Pause | : Current track paused | 888 | : Playing Track |
| USB or SD | : USB or SD Card playing source | 88:88:88 | : Elapse Time |
| REP | : Repeat Current Track | RAN | : Random Play |
| REP ALL | : Repeat All Tracks | | : Volume Indicator |
| REP FOLDER | : Repeat Current Folder | A→B | : A→B Repeat |

Front Panel of Remote Control

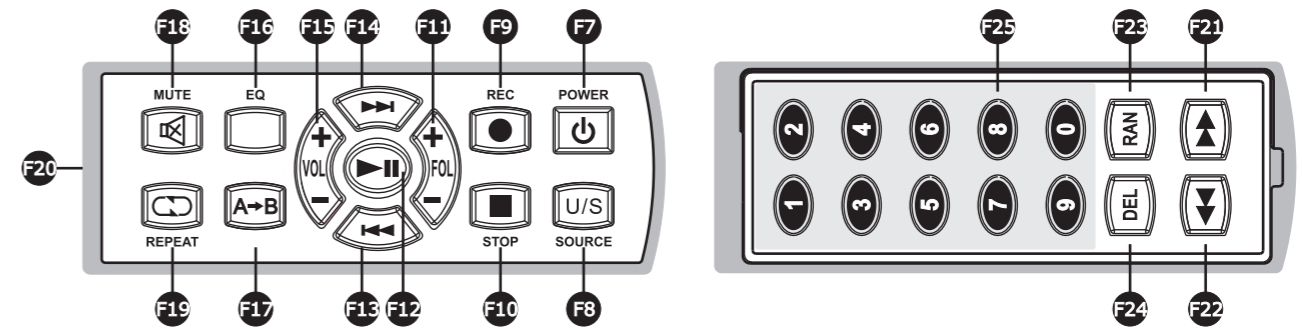

- F7 POWER** : POWER On/Off
- F8 SOURCE Mode** : Select USB or SD Card source
- F9 REC** : RECORD
- F10 STOP**
- F11 FOLDER + -** : Folder up or down change
- F12 PLAY** : PLAY or PAUSE
- F13 ⏮** : Previous track or press & hold for fast previous track
- F14 ⏭** : Next track or press & hold for fast forward track
- F15 VOL + -** : Raises or Lowers volume
- F16 EQ** : Equalizer
- F17 A→B** : Playing back a specified section repeatedly (A→B Repeat)
- F18 MUTE** : Mute audio
- F19 REPEAT** : Repeat audio
- F20 Detachable IR (Infrared) Remote**
- F21 NEXT** : Fast-Forward 3 seconds. Press & hold for continuous fast-forward of current track.
- F22 PREV** : Fast-Rewind 3 seconds. Press & hold for continuous fast-rewind of current track.
- F23 RAN** : Plays tracks randomly.
- F24 DEL** : Deletes MP3 playback or recorded track.
- F25 Number buttons** : 0~9 for track selection.

REPLACING THE REMOTE CONTROL BATTERY

This remote control uses a CR2032 lithium coin battery that is commonly by in small electronic devices and easy to replace. You'll find these batteries at most electronics, supermarkets and at drug stores. Replace with a new, fresh CR2032 when the remote's battery power is low or remote control starts to work erratically.

- Press and hold both sides of battery compartment. Pull the battery compartment out and remove the battery (pictured below).
- Insert a replacement CR2032 lithium battery with the positive (+) side facing up.
- Gently slide the battery compartment closed. It locks automatically.

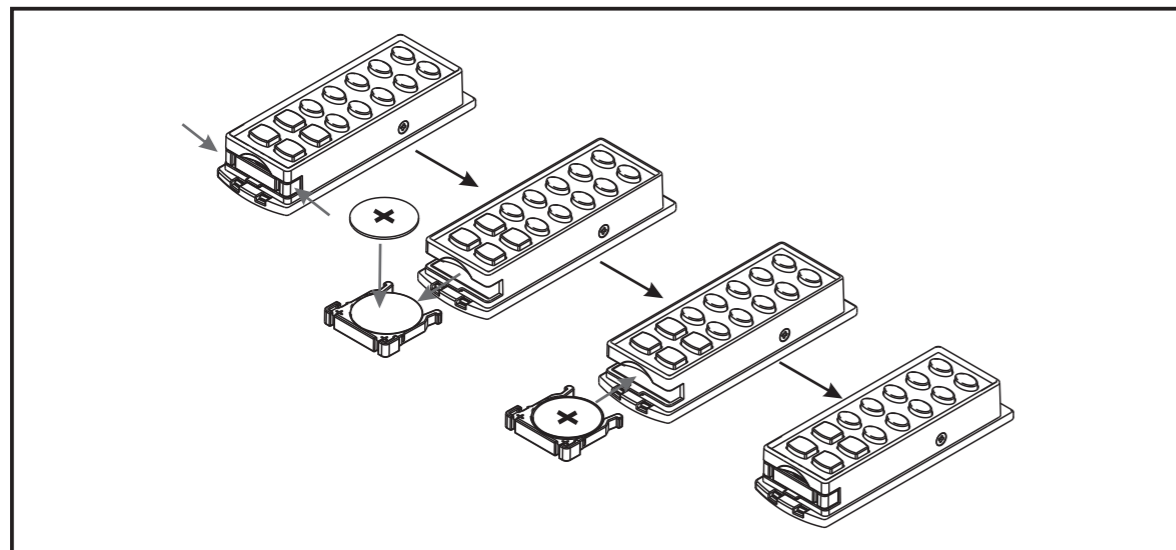

BATTERY WARNINGS

- Keep the remote control battery away from children. It may cause a fire or chemical burn if mishandled.
- Do not recharge, disassemble, heat above 212° F (100° C), or incinerate.
- Dispose of batteries according to local regulations. Please recycle when possible.
- Do not dispose as household waste or in a fire as they may explode.
- Replace only with CR2032 lithium battery.
- Replace only with a battery of the correct type and model number.

OPERATION FUNCTIONS

Power On:

- ON and Volume Indicator are displayed.



Media Slots:

- **USB Disk:** Insert USB into the USB port.
- **SD Card Reader:** Insert a SD card with gold contacts facing up and label facing down.
- Format USB and SD card before playback. Format standard is FAT.

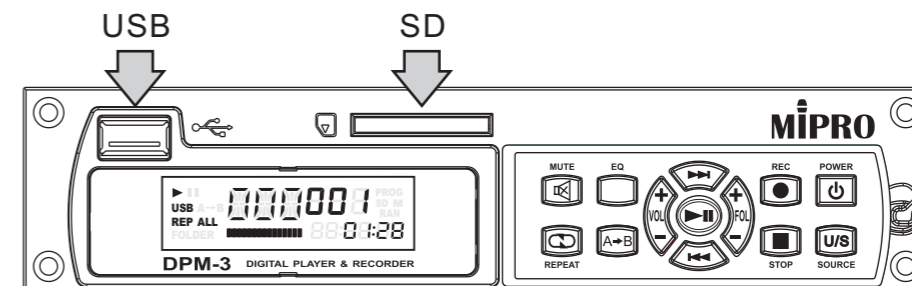

Media Source Selection:

- Once a USB or SD card is inserted, it detects media source automatically and playback starts.

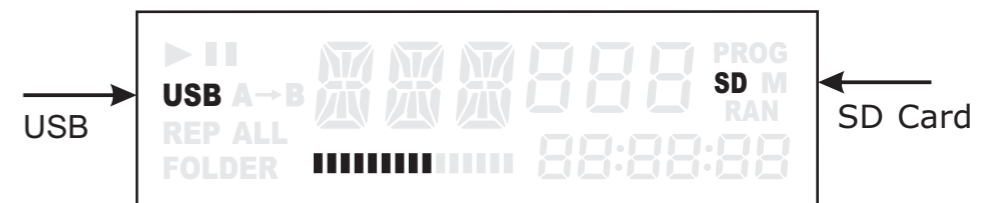

Nod (NO DISK) displays when it is unable to detect or read a media source.

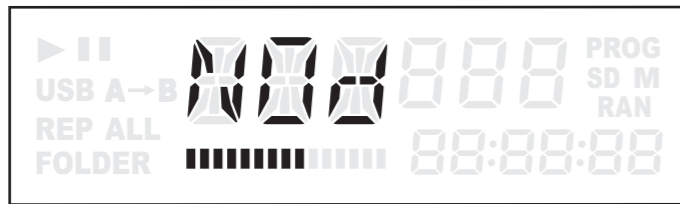

STOP: Playback is stopped



PLAYBACK: Normal playback display.



PAUSE: Paused display



Fast Forward:

- NEX appears when pressed.
- Track Time will be fast forwarded.
- Playback starts when button is released.



Fast Rewind:

- BCK appears when pressed.
- Track Time will be fast rewinded.
- Playback starts when button is released.



Volume Indicator: 0 to 15

- Press once + to increase and - to decrease volume.
- Press and hold to increase and decrease incrementally.
- VOL & numeric volume loudness display appears for approximately 2 seconds during operation.



SKIP:

- Press to skip to next or previous track.







FOL (Folder):

- Press to skip to next or previous folder.
- If both USB and SD care are both plugged when FOL + or - is pressed it will not skip to next or previous folder, instead it jumps USB to/from SD card alternatively.



Music Playback:

- Press PLAY  for playback. Folder and track will be displayed.
- Press PLAY  again during playback to pause. Press PLAY  again to resume playback.
- Press STOP  to stop playback.

Two options for the order of playing music:

- Copy the desired songs into USB storage unit one by one until copying all the desired songs. By this way, the play sequency will be based upon the order of music being programed into USB storage unit.
- If the desired songs will be divided into different folders, please number the songs when copying them into folders then copying the said folders into USB storage unit. Pleaa note the songs must be numbered by the same digit like 00, 01, 02 or 000, 001, 002 or 0000, 0001, 0002.. and so on.

Repeat Playback:

- Press REPEAT  to select one of the repeat options.
- No display: No repeat of any track.
- REP: Repeat same track.
- REP ALL: Repeat all tracks.
- REP FOLDER: Repeat folder.

不顯示

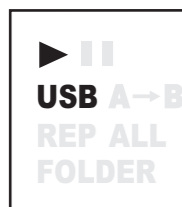

REP

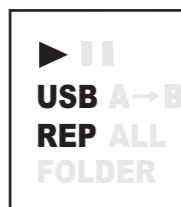

REP ALL



REP FOLDER

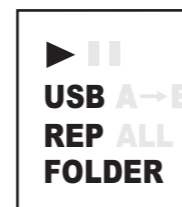

A→B Repeat:

- Press A→B once to specify the starting point of A-B repeat. A appears
- Press A→B once to specify the starting point of A-B repeat. A appears
- Press A→B again to specify the ending point of the A-B repeat. B appears
- A→B Repeat starts automatically and repeatedly.
- To cancel, press A→B again.



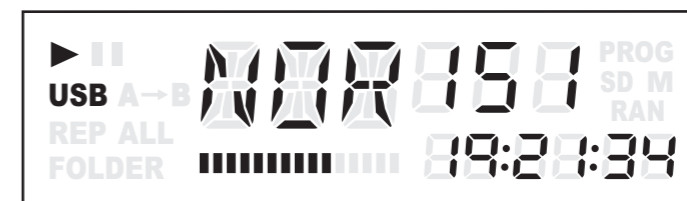

EQ (equalization):

- Press EQ for one of the 7 equalization effects: NOR→ROC→POP→CLA→SOF→JAZ→BAS.
- NOR:** Normal
ROC: Rock
POP: Popular
CLA: Classic
SOF: Soft
JAZ: Jazz
BAS: Bass



To Delete Track:

- NO is displayed once DEL is pressed. Press NEXT  or PREV  will display either YES or NO. To delete track, press DEL during YES display.

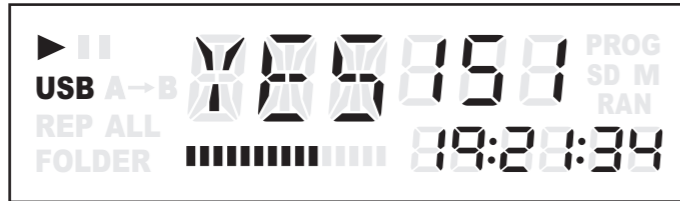

To Record Track:

- Recording input can be converted into WAV file format. It can be saved into a USB or SD Card.
- If recording input signals are to be saved into a USB or SD Card, insert a USB or SD card into slot and ascertain the intended Source. Recording time is displayed on the bottom right. Press recording button and REC flashes on the LCD display to indicate recording in progress. Press STOP button to stop recording and it converts to WAV format and saved.
- Recorded tracks are stored in VOC file folder.
- Press PLAY to play previous recorded track.

** Press & hold REC for 2 seconds to enter recording folder. Press & hold for another 2 second to cancel recording and return to normal playback mode.





MUTE:

- Press MUTE to mute. Press MUTE again returns to playback.



Playback recorded speech or music tracks:

- Press FOL "+"及"-" to seek intended tracks in VOC folder.
- Press & hold REC to fast forward recorded folder and release until VOC folder is displayed. REC  playback is now active. Press PLAY/PAUSE  for playback.
- To return to normal playback during REC  playback mode, press & hold REC.

Random Playback:

- Press RAN  for random playback. RAN is displayed.
- Press RAN again for resume normal playback. RAN is no longer displayed.



Numeric Track Selection:

- Up to 999 tracks can be selected and displayed for playback. Enter intended numbers on the numeric keypad, located on the back of the remote, for fast track selection

 →  →  : Press for track # 134

 →  : Press for track # 68

INSTALLATION OF MIPRO CD/MP3 PLAYER

- Using a Phillips-head screwdriver (not supplied) remove the screws to remove protection cover panel. (Figure 5-1)
- Gently insert the CD/MP3 player module (optional) into the slot. (Figure 5-2)
- Make sure the back edge connector is aligned and firmly connected. (Figure 5-3)
- Tighten up the screws. (Figure 5-4)

OPERATIONS OF CD/MP3 PLAYER

- See a separate CD player manual enclosed in the master carton.

(Figure 5-1)

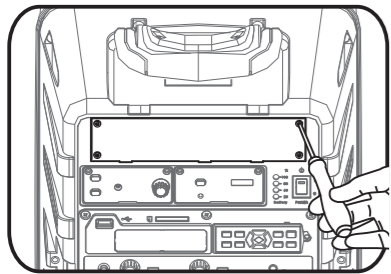

(Figure 5-2)

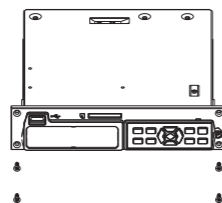
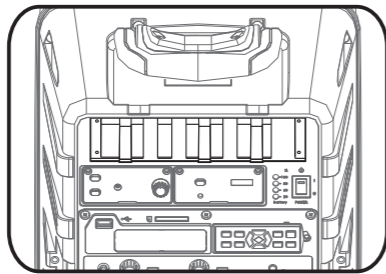

(Figure 5-3)

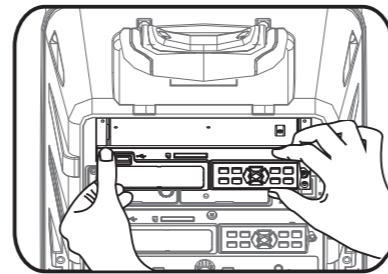

(Figure 5-4)

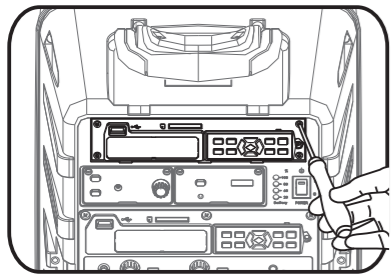

HELPFUL OPERATING TIPS

1. We recommend placing sound system between the target audience and the presenter, facing the audience and raised above their heads using a speaker stand or table. This set-up helps prevent the annoying feedback by keeping wireless & wired microphone users behind the sound system. The internal power supply rechargeable batteries should be kept fully charged. Always charge the system after use.
2. If you operate the system from an external AC power supply, then the internal battery supply will charge at the same time, a very useful feature.
3. If the LED indicator on the power switch flashes after first turning the unit on or it starts to do so during use on the internal DC supply (low battery warning), you should switch to the AC power supply by using the AC power cord.
4. Before turning power on to the unit, please set all volume controls to their minimum level. This prevents any loud 'thumps' at power on. Adjust the volume controls afterward.
5. Never place any microphone in front or close in front of the speaker otherwise damaging feedback (both to the operators ears and the system) could occur.
6. The MA-505-EXP extension speaker is rated at 100 watts @ 4 ohms. Please take care not to short out the speaker cables otherwise unwarranted damage could be done to the system amplifier.
7. Do not expose the device to rain, use it near water or in damp or wet conditions, or place containers on it containing liquids which might spill into any openings.
8. Rechargeable batteries have a limited amount of charge cycles before they are considered to be consumed. Once consumed, a replacement battery is recommended.
9. You may choose to replace your battery while it still has a little juice left, or wait until the battery does not hold enough energy to power your device at all to replace it. As with all batteries, proper disposal is essential. Putting any battery directly in the trash harms the environment.
10. Battery warranty does not cover normal wear and tear, crash or water damage, modifications, failure to perform routine maintenance like not recharging for an extended period of time or months, or any damages arising as a result of improper use.

TROUBLESHOOTING-PORTABLE PUBLIC ADDRESS

PROBLEM	POSSIBLE CAUSE	SOLUTION
No Sound or Faint Sound From Speaker	Volume turned down	Adjust volume
	Power switch is turned off	Turn power switch on
Power Indicator Not On	Power switch is turned off	Turn power switch on
	Rechargeable Battery is discharged	Plug into AC outlet to recharge
	Rechargeable Battery is "dead"	Replace battery and plug into AC outlet to recharge
Distorted Sound From Speaker	Volume set too high	Reduce volume
	Excessive wind noise or breath "pops"	Use windscreen on wireless & wired microphones.
	Input signal too strong	Adjust input signals
Excessive Feedback	Microphone too close or directly in front of the speaker	Move microphone away from the speaker
	Volume set too high	Reduce volume
	Microphone too far from sound source (requiring the volume to be turned up to compensate)	Speak closer to the microphone or move microphone closer to sound source
Weak, Distorted Sound Power Indicator Flickers	Batteries level is low	Plug into AC outlet to recharge
Excessive Hum or Noise	Input Cable not shielded	Use shielded cable
Shortened Battery Life	Old or overused battery	Recharge or replace battery
	Battery is not charged for over 3~4 months	Recharge or replace battery
Battery CHARGE Indicator Not Flickering when plugged into AC Outlet	Rechargeable Battery is "dead"	Replace battery
	Battery is not charged for over 3~4 months	Recharge or replace battery
	Battery is fully charged (CHARGE indicator is lit)	N/A

TROUBLESHOOTING-WIRELESS MICROPHONE SYSTEMS

PROBLEM	POSSIBLE CAUSE	SOLUTION
No Sound From Speaker	Master or receiver volume turned down	Adjust volumes
	Transmitter or receiver switch is turned off	Turn transmitter or receiver switch on
	Receiver and transmitter have different frequencies	See "Set-up Receiver & Transmitter Frequencies" section
	Transmitter battery is low or no battery inside	Replace or insert new battery
	Headset or lavalier microphone is not plugged into bodypack transmitter	Plug headset or lavalier microphone into bodypack transmitter
Distortion or Unwanted Noise Bursts	Interference	Remove nearby sources of RF interference (computers, amplifiers, karaoke machines, digital effects, CD players, etc)
	Noise Indicator is lit	Adjust "Sensitivity" on receiver
		If problem persists, change Receiver & Transmitter frequencies.
		See "Set-up Receiver & Transmitter Frequencies" section
Sound Dropouts	Out of operating range	Move transmitter closer to receiver
	Obstructions between the receiver and transmitter	Remove obstructions or reposition
		Line-of-sight between receiver & transmitter
	Weak Transmitter Battery	Replace Transmitter Battery
	Interference	Change Receiver & Transmitter frequencies
See "Set-up Receiver & Transmitter Frequencies" section		

FAQ - PORTABLE PA**Q: Why is my portable PA not recharging (indicator is not flashing) when plugged into an AC outlet?**

A1: Ensure AC Power button is pressed (next to the MRM-70B receiver module slot). An un-pressed button (out) will prevent recharging of the battery. (MA-707)

A2: The rechargeable battery life has likely ended. Replaced with new, fresh rechargeable battery.

Q: How to adjust for optimal sound volume?

A: If the portable system has both Master & Microphone volumes, we recommend turning the Master volume to about 3pm (clockwise) first and about 1~2pm (clockwise) for Microphone or other volumes.

Q: How to prevent and minimize the annoying feedback?

A1: Do not stand directly in front of the speakers; keep mics away from speakers.

A2: Avoid pointing microphone towards the speakers.

A3: The microphones should be behind the speakers wherever possible.

A4: Locate the portable PA between the crowd and the presenters and facing the crowd.

A5: Turn down the sound level coming out of the portable PA/speakers if necessary.

A6: Place the speakers above the head of the crowd.

Q: What if I need more power to cover a larger crowd?

A: Two or more portables can be used with one wireless microphone transmitter. Ascertain that the receiver frequency in each portable coincides with the wireless microphone.

Q: Can I play music through the systems?

A: Yes. All MIPRO portables have line inputs (3.5mm (mono) mini jack, RCA, ¼" mono phone), which will accept input from an external iPod, MP3, CD, cassette, VCR, DVD players. As well, modular CD players can be inserted into most models.

FAQ - RECHARGEABLE BATTERY**Q: How to Charge the Battery?**

A: Simply plug into a power outlet using the included power cable and adapter. "Flashing" LED indicates it is charging. The main power switch can be on or off position during charging. Microphones or music can be used during charging & power is on.

Q: How to Spot System Low Battery?

A: When Power LED is lit (MA-705 & MA-707) or Charge LED is lit (MA-101, MA-101a, MA-101A & MA-101B) or one indicator remaining in battery meter (MA-100, MA-202, MA-202B, MA-303, MA-505, MA-708, MA-808). Plug into a power outlet to recharge ASAP.

Q: Average Life Span of Sealed Lead-Acid Rechargeable Battery?

A: The batteries should have a life of approx. 2 years if used and maintained properly. Battery life is determined by temperature, depth and rate of discharge, and the number of charges and discharges (called cycles).

Q: When to Replace the Battery?

A1: Power LED indicator is not "lit" when power on. (No battery voltage).

A2: LED indicator or meter is not "flashing" when plugged-in.

A3: Getting 1~2 hours operating time per charge.

A4: When battery has been used extensively for 2~3 years or more.

RECHARGEABLE BATTERY GUIDE

Tips - To Prolong the Life of Rechargeable Batteries

- ☑ Always charge the batteries before first and after use.
- ☑ Always store portable system with batteries in a fully charged condition.
- ☑ Always power off the portable system and transmitter/mic when NOT in use.
- ☑ It is OK to leave the system plugged into a power outlet when not being used for a long time. The built-in automatic protection circuitry will auto shut-off when fully charged. It will not harm the system or the battery.
- ☑ Fully charge the system at least once every 3 months. Battery may not charge if not charged for a prolonged periods of time.
- ☑ Store in dry, cool place away from heat. Elevated temperature reduces longevity.

CAUTION: DO NOT recharge other types of batteries and connect a battery's negative terminal to another batteries positive terminal. An explosion and/or a fire could occur as a result.

OPTIONAL MA-505 ACCESSORIES**MA-505EXP - Extension Speaker for MA-505**

Unpowered extension speaker (10-meter speaker cable included)

MB-35 - 25V/4.5AH Rechargeable Battery

Rechargeable lithium battery

MS-70 - Speaker Tripod Stand

Adjustable stand for MA-505 portable PA system

SC-50 - Storage Cover

Storage cover and separate storage for mic cable, transmitters, microphone & battery

MM-107 - Handheld Wired Microphone

MIPRO's Hypercardioid Dynamic Microphone with cable.

CDM-2P - CD/USB Player

Plays standard 12cm (5") audio CD & MP3 CD.

ASP-30 - Aerobic Sports Pouch

Sweat-resistant transmitter pouch belts for MIPRO bodypack transmitters.

MIPRO WIRELESS MICROPHONE SYSTEMS**MRM-70B UHF 16-Channel Diversity Receiver Module**

Automatic receiver frequency scan & ACT functions

ACT-32H - Handheld Transmitter Microphone (AA x 2: not included)**ACT-52H - Handheld Transmitter Microphone (AA x 2: not included)****ACT-32T - Body Pack Transmitter (AA x 2: not included)****ACT-52T - Body Pack Transmitter (AA x 2: not included)**

(microphone not included - see below)

MU-53HN (black) ; MU-53HNS (beige) Premium Headworn Microphone

Uni-directional, Premium 10mm, Ideal for speech and singing. Works with all MIPRO bodypack transmitters

MU-55HN (black) ; MU-55HNS (beige) Subminiature Headworn Microphone

Omni-directional, 4.5mm, Sweat-proof, Ideal for speech. Works with all MIPRO bodypack transmitters

MU-13 (beige) Premium Single-sided Earworn Microphone

Omni-directional, ultra small & lightweight 3mm, Ideal for speech. Works with all MIPRO bodypack transmitters

MU-53L (black) ; MU-53LS (beige) Premium Lavalier Microphone

Uni-directional, 10mm, High-gain-before-feedback, warm, clear sound. Works with all MIPRO bodypack transmitters

MU-55L (black) ; MU-55LS (beige) Subminiature Lavalier Microphone

Omni-directional, 4.5mm, Low visibility, Works with all MIPRO bodypack transmitters

Dual-Channel +Bluetooth +DPM-3 (OPTIONAL)

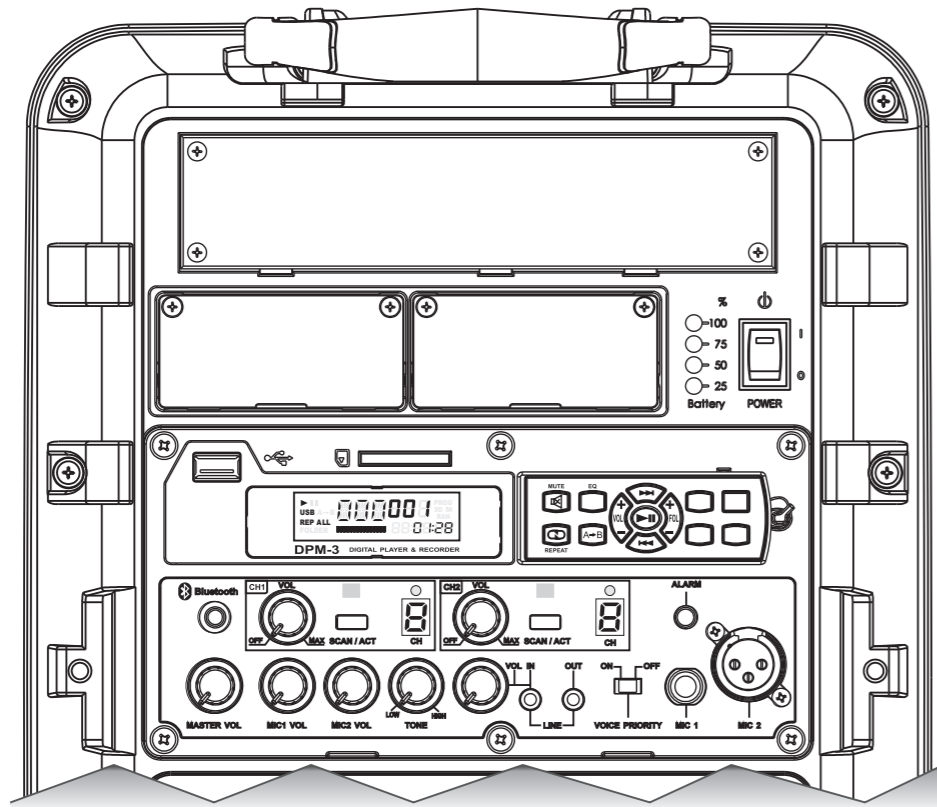

Bluetooth, DPM-3 (OPTIONAL)

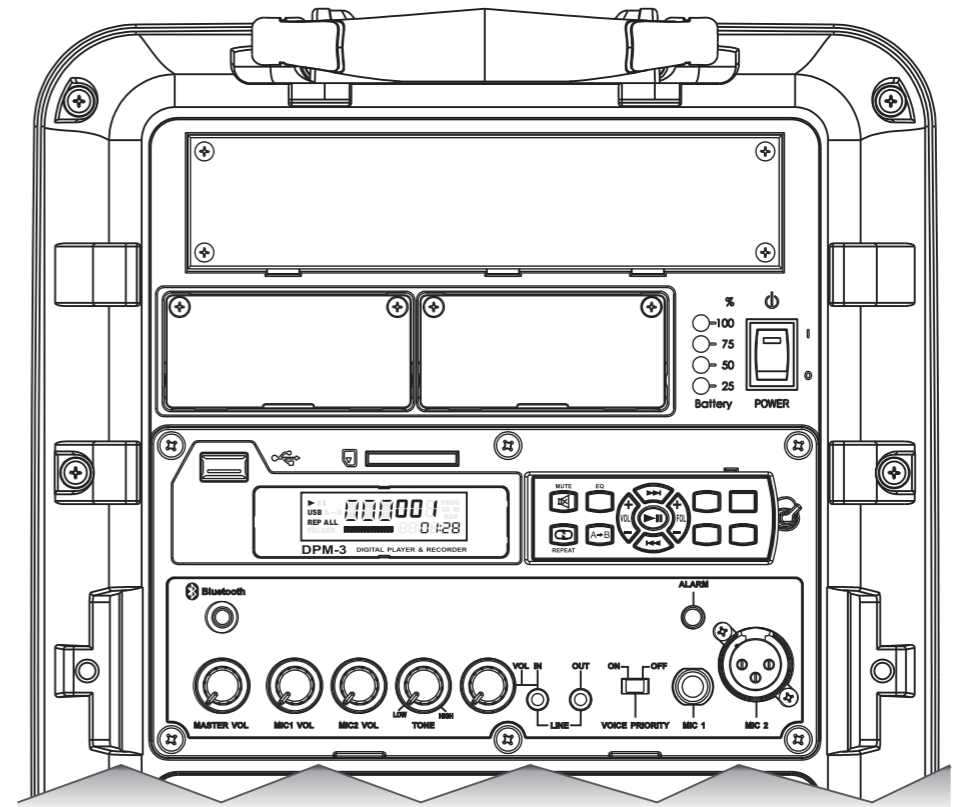

Single-Channel +Bluetooth +DPM-3 (OPTIONAL)

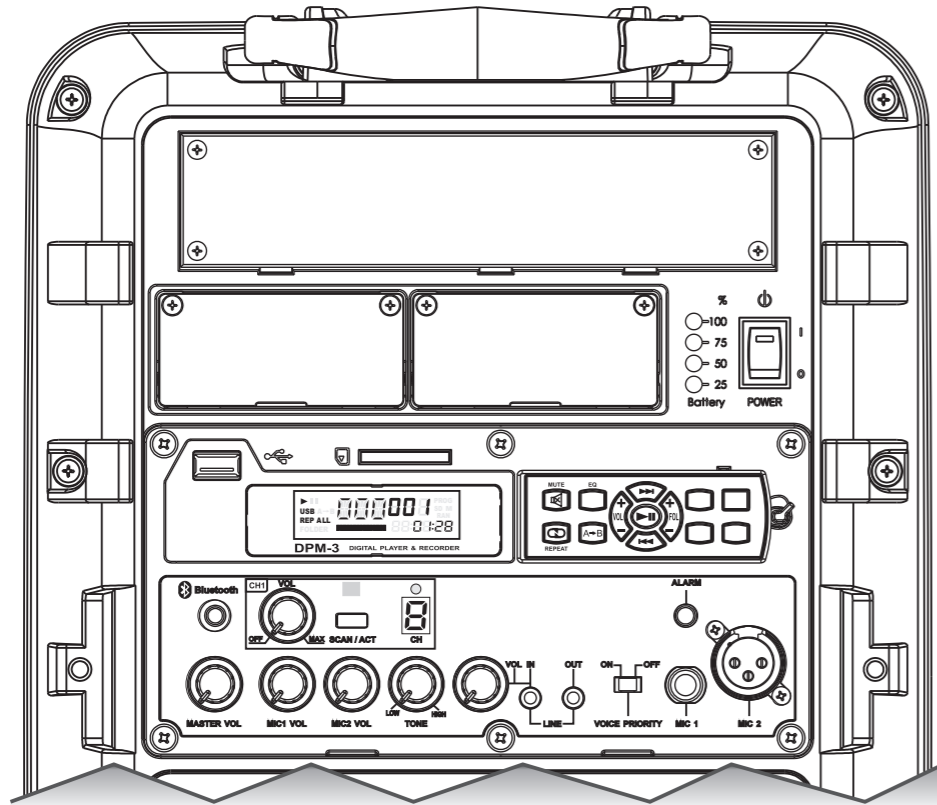

Bluetooth, No DPM-3 (OPTIONAL)

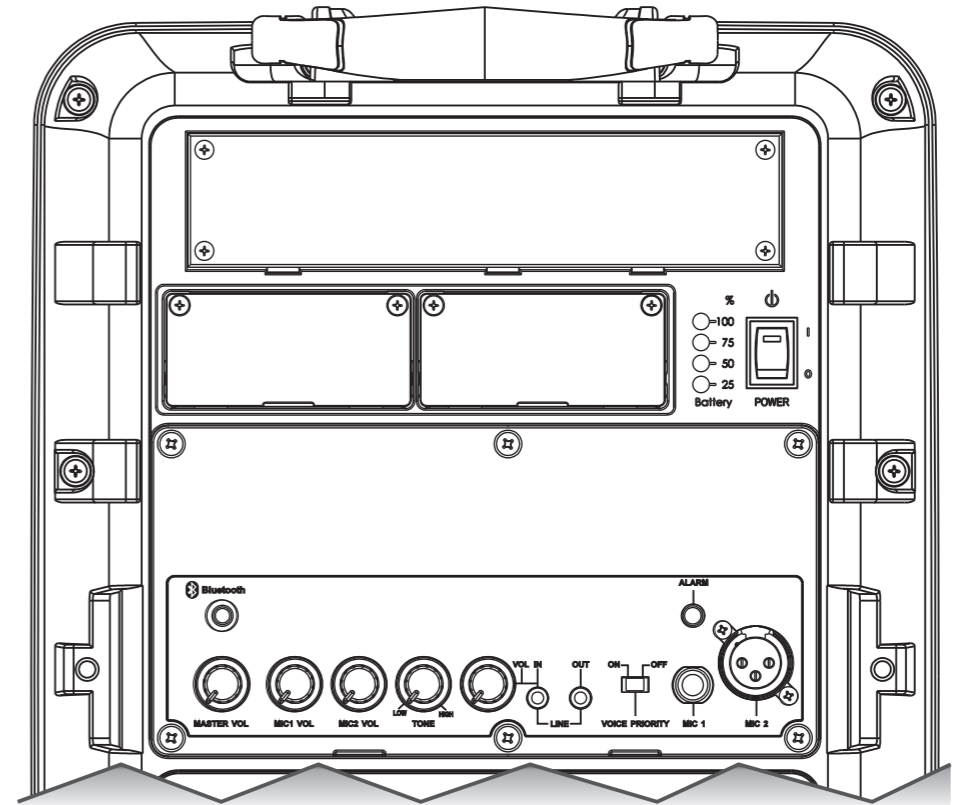

No Bluetooth, No DPM-3 (OPTIONAL)

