

MIPRO®

MICROPHONE PROFESSIONALS

User Guide

MA-100 Single-Channel / MA-100D Dual-Channel Personal Wireless Megaphone



MA-200 Single-Channel / MA-200D Dual-Channel Personal Wireless Megaphone



MA-300 Single-Channel / MA-300D Dual-Channel Portable Wireless PA System





! IMPORTANT SAFETY INSTRUCTIONS !

1. Read these instructions.
2. Keep these instructions.
3. Heed all warnings.
4. Follow all instructions.
5. Do not use this apparatus near water.
6. Clean only with a dry cloth.
7. Do not block any ventilation openings. Install in accordance with the manufacturer's instructions.
8. Do not install near any heat sources such as radiators, heat registers, stoves, or other apparatus (including amplifiers) that produce heat.
9. Do not defeat the safety purpose of the polarised or ground plug: A polarised plug has two blades with one wider than the other. The wide blade is provided for your safety. When the provided plug does not fit into your outlet, consult an electrician for replacement of the obsolete outlet.
10. Protect the power cord from being walked on or pinched particularly at plug, convenience receptacles, and the point where they exit from the apparatus.
11. Only use attachments/accessories specified by the manufacturer.
12. Use only with a cart, stand, tripod, bracket, or table specified by the manufacturer, or sold with the apparatus. When a cart is used, use caution when moving the cart/apparatus combination to avoid injury from tip-over.
13. Unplug this apparatus during lightning storms or when unused for long periods of time.
14. Refer all servicing to qualified service personnel. Servicing is required when the apparatus has been damaged in any way, such as power-supply cord or plug is damaged, liquid has been spilled or objects have fallen into the apparatus, the apparatus has been exposed to rain or moisture, does not operate normally, or has been dropped.
15. To reduce the risk of fire or electric shock, do not expose this apparatus to rain or moisture.
16. Apparatus should not be exposed to dripping or splashing and no objects filled with liquids, should be placed on the apparatus.
17. Use only with the battery which specified by manufacturer.
18. The power supply cord set is to be the main disconnected device.



WARNING

1. **FOR OUTDOOR USE:**
To reduce the risk of fire or electric shock, do not expose this apparatus to rain or moisture.
2. **UNDER WET LOCATION:**
Apparatus should not be exposed to dripping or splashing and no objects filled with liquids, such as vases should be placed on the apparatus.
3. **SERVICE INSTRUCTIONS:**
CAUTION - These servicing instructions are for use by qualified service personnel only. To reduce the risk of electric shock, do not perform any servicing other than that contained in the operating instructions unless you are qualified to do so.

	
	<p>This symbol indicates that dangerous voltage constituting a risk of electric shock is present within this unit.</p>
	<p>This symbol indicates that there are important operating and maintenance instructions in the literature accompanying this unit.</p>

FC & IC - ID

THIS DEVICE COMPLIES WITH PART15 OF THE FCC RULES AND RSS-123 ISSUE2 OF CANADA. OPERATION IS SUBJECT TO THE FOLLOWING TWO CONDITIONS:

- (1) This device may not cause interference.
- (2) This device must accept any interference, including interference that may cause undesired operation of the device. This equipment complies with FCC RF radiation exposure limits set forth for an uncontrolled environment.

Disposal Dispose of any unusable devices or batteries responsibly and in accordance with any applicable regulations.



2005-08-18

Disposing of used batteries with domestic waste is to be avoided!

Batteries / NiCad cells often contain heavy metals such as cadmium(Cd), mercury(Hg) and lead(Pb) that makes them unsuitable for disposal with domestic waste. You may return spent batteries/ accumulators free of charge to recycling centres or anywhere else batteries/accumulators are sold.

By doing so, you contribute to the conservation of our environment!

Federal Communication Commission Interference Statement

This equipment has been tested and found to comply with the limits for a Class B digital device, pursuant to Part 15 of the FCC Rules. These limits are designed to provide reasonable protection against harmful interference in a residential installation.

This equipment generates, uses and can radiate radio frequency energy and, if not installed and used in accordance with the instructions, may cause harmful interference to radio communications. However, there is no guarantee that interference will not occur in a particular installation. If this equipment does cause harmful interference to radio or television reception, which can be determined by turning the equipment off and on, the user is encouraged to try to correct the interference by one of the following measures:

- Reorient or relocate the receiving antenna.
- Increase the separation between the equipment and receiver.
- Connect the equipment into an outlet on a circuit different from that to which the receiver is connected.
- Consult the dealer or an experienced radio/TV technician for help.

FCC Caution: To assure continued compliance, any changes or modifications not expressly approved by the party responsible for compliance could void the user's authority to operate this equipment. (Example - use only shielded interface cables when connecting to computer or peripheral devices).

End Product Labeling

This transmitter module is authorized only for use in devices where the antenna may be installed such that 20 cm may be maintained between the antenna and users. The final end product must be labeled in visible area with the following:

End Product Manual Information

The user manual for end users must include the following information in a prominent location "IMPORTANT NOTE: To comply with FCC RF exposure compliance requirements, the antenna used for this transmitter must be installed to provide a separation distance of at least 20cm from all persons and must not be colocated or operating in conjunction with any other antenna or transmitter." This device complies with part 15 of the FCC rules. Operation is subject to the following two conditions (1) This device may not cause harmful interference and (2) This device must accept any interference received, including interference that may cause undesired operation.

IMPORTANT NOTE: In the event that these conditions can not be met (for example certain laptop configurations or colocation with another transmitter), then the FCC authorization is no longer considered valid and the FCC ID can not be used on the final product. In these circumstances, the OEM integrator will be responsible for reevaluating the end product (including the transmitter) and obtaining a separate FCC authorization. This device is intended only for OEM integrators under the following conditions: The antenna must be installed such that 20 cm is maintained between the antenna and users. As long as a condition above is met, further transmitter test will not be required. However, the OEM integrator is still responsible for testing their end product for any additional compliance requirements required with this module installed (for example, digital device emissions, PC peripheral requirements, etc.).

I. Part Names

1. MA-100 Personal Wireless Megaphone

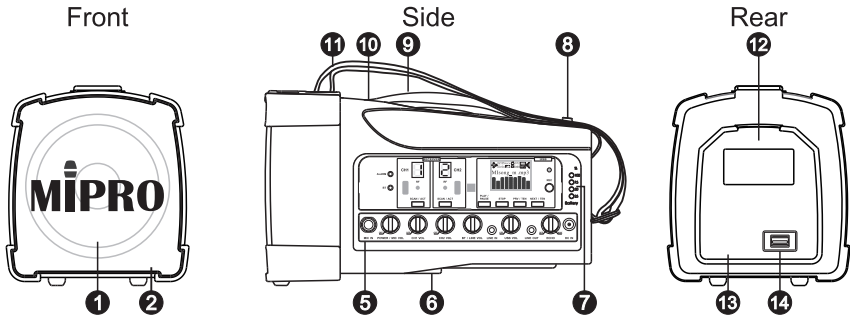

2. MA-200 Personal Wireless Megaphone

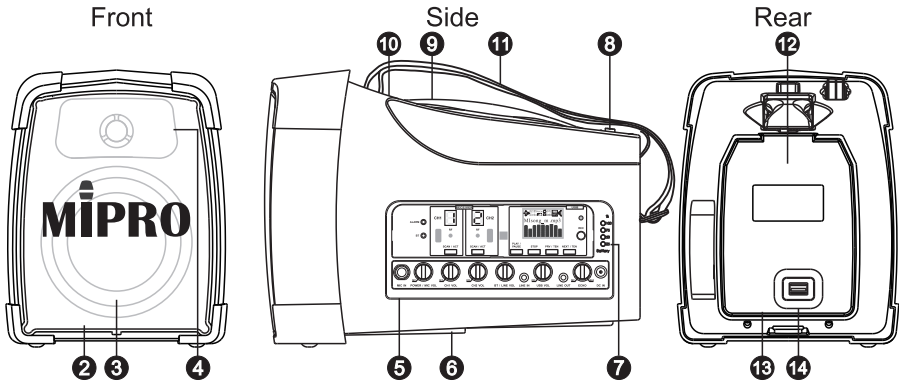

3. MA-300 Portable Wireless PA System

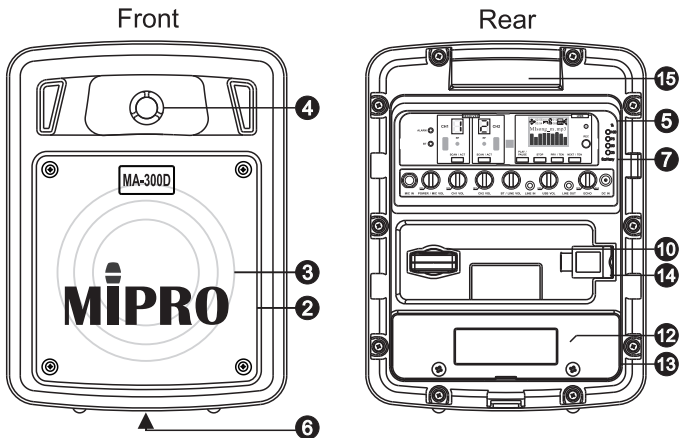

- | | | |
|---------------------------------|---|-------------------------------------|
| 1 Speaker | 6 Microphone Stand Adapter | 11 Shoulder Belt |
| 2 Speaker Cover | 7 Battery Gauge & Battery Charging Indicator | 12 Battery Compartment |
| 3 Bass Speaker | 8 Battery Compartment Cover Release Button | 13 Battery Compartment Cover |
| 4 Treble Speaker | 9 Handle | 14 USB Disk Slot |
| 5 Function Control Panel | 10 Bluetooth® Receiver Module Slot | 15 Carrying Handle |

II. Control Panel Part Names

1. Dual-channel

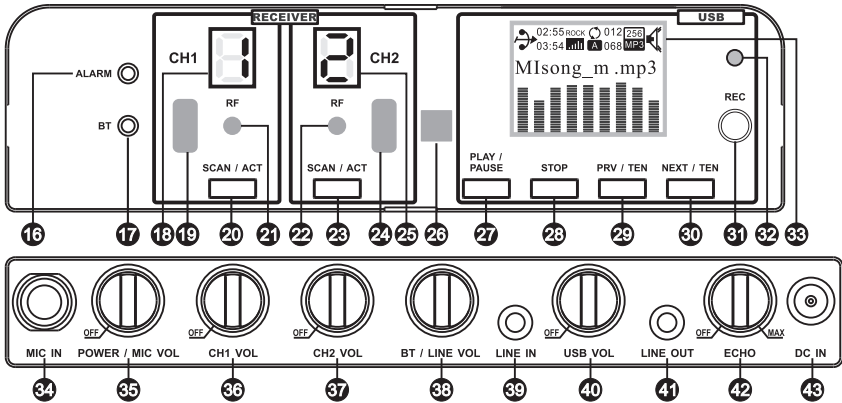

2. Single-channel

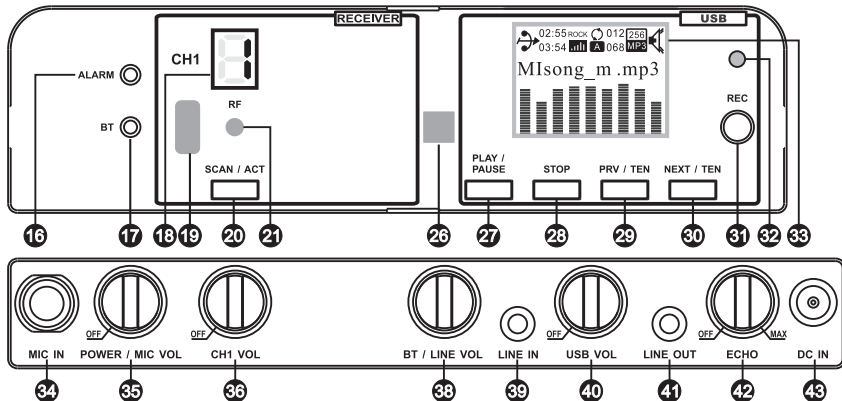

- 16 Alarm Siren Button
- 17 Bluetooth® Power & Indicator
- 18 Receiver 1 Channel Display
- 19 Receiver 1 Infrared (IR) Sync Window
- 20 Receiver 1 Channel Scan & Sync Button
- 21 CH1 RF Indicator
- 22 CH2 RF Indicator
- 23 Receiver 2 Channel Scan & Sync Button
- 24 Receiver 2 Infrared (IR) Sync Window
- 25 Receiver 2 Channel Display
- 26 USB Player Infrared (IR) Window
- 27 PLAY/PAUSE Button
- 28 STOP Button
- 29 PRV/TEN: Previous/Previous Ten Button
- 30 NEXT/TEN: Next/Next Ten Button
- 31 Recording Button
- 32 Recording Indicator
- 33 USB Player Display
- 34 MIC IN: 6.3 mm Wired Microphone Input
- 35 POWER/MIC VOL: Power/Volume Control
- 36 CH1 VOL: Channel 1 Wireless Mic Volume Control
- 37 CH2 VOL: Channel 2 Wireless Mic Volume Control
- 38 BT / LINE VOL: Bluetooth / Line Input Volume Control
- 39 LINE IN: 3.5 mm Line Input Jack
- 40 USB VOL: USB Volume Control
- 41 LINE OUT: 3.5 mm Line Output Jack
- 42 ECHO: Echo On/Off and Volume Control
- 43 DC IN: DC Input Jack

III. Operating Instructions

1. Wired Microphones:

- (A) Turn on the Power/Volume Control **35** . Plug a microphone into MIC IN **34** .
- (B) Adjust the Power/Volume Control **35** to the desired volume.
- (C) Use Echo Control **22** to activate the echo effect and adjust to the desired volume.
- (D) Mic Volume Control and other audio inputs can be used concurrently.
- (E) To end the usage, turn off the Power/Volume Control **35** .

2. Wireless Microphones:

- (A) Turn on the Power/Volume Control **35** .
- (B) Turn on CH1 / CH2 Power and Volume Control **36** / **37** , CH1 / CH2 Indicator **18** / **25** glows.
- (C) Power on CH1 / CH2 transmitter, RF Indicator **21** / **22** lights.
- (D) Adjust CH1 / CH2 Power and Volume Control **36** / **37** to desire volume.
- (E) Like wired microphones, wireless microphones can use Echo Control. Wireless Mic Volume Controls and other audio inputs can be used concurrently.
- (F) It is not possible to transmit two wireless microphones on the same channel to one system. Only one transmitter can be used at a time on that channel. Be sure to turn off one of the two transmitters to avoid interference. The same wireless microphone can transmit to multiple systems on the same channel for a wider and expanded coverage.
- (G) To end the usage of wireless microphones, turn off the CH1 / CH2 Power and Volume Control and Power/Volume Control.

3. Line-input:

- (A) Turn on the Power/Volume Control **35** .
- (B) Connect the external audio source to the LINE IN jack **39** and adjust the audio source to adequate volume.
- (C) Adjust BT/LINE VOL **33** to the desired volume.

4. Line-output:

During power-on status, all mixed audio signals can be output via LINE OUT jack **41** .

5. USB Operating Instructions:

(A) Music Playback:

- (1) Turn on the Power/Volume Control **35** .
- (2) Turn on USB Volume Control **40** . LCD Screen **33** glows. Adjust the volume to an adequate position.
- (3) Press PLAY/PAUSE Button  **27** to pause. Press it again for playback.

- (4) Press STOP Button 23 to stop playback. Press PLAY/PAUSE for playback.
- (5) Short press ►► 30 for the next track; long press to fast forward to the next ten tracks.
- (6) Short press ◀◀ 29 for the last track; long press to fast backward to the last ten tracks.
- (7) To end the music playback, turn off USB Volume Control and Power/Volume Control.

(B) Record Tracks:

- (1) Insert a USB into USB Player Slot 14. Turn on Power/Volume Control 35 and USB Volume Control 40. LCD screen 33 glows and starts to play music.
- (2) Press STOP Button 23 or Recording Button 31 during playback will stop the playback. The screen shows STOP. Then press the Recording Button and Recording Indicator 32 glows and is ready to record. Press the PLAY/PAUSE Button to start recording and Recording Indicator blinks.
- (3) Press STOP Button to stop recording and turn the recorded file into MP3 format. The recorded file will play automatically after being saved.

(C) Two options for the order of playing music:

- (1) Copy the desired songs into a USB storage unit one by one until copying all the desired songs. In this way, the play sequence will be based upon the order of music being programed into the USB storage unit.
- (2) Number the desired songs when copying them into folders. Then copy the folders into a USB storage unit. Please note the songs must be numbered by the same digit like 00, 01, 02 or 000, 001, 002 or 0000, 0001, 0002... and so on.

6. Bluetooth® Connection:

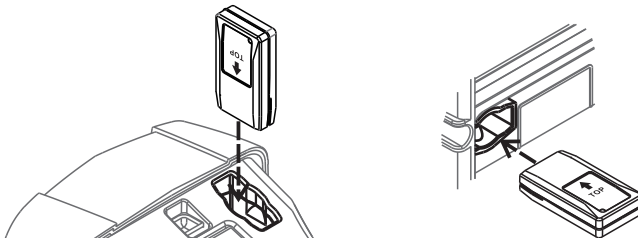

Pair Bluetooth® receiver with the mobile devices and play the music via the devices.

- (A) Plug the Bluetooth® receiver into the slot aligning the print side along with the control panel (MA-100 & MA-200) or facing the print side up (MA-300).
- (B) Turn on Power/Volume Control 35. Activate the Bluetooth function on the mobile device and bring the device close to the system. Turn the Bluetooth/Line Volume Control 38 to the desired volume.
- (C) Press & hold the Bluetooth Power & Indicator 17 for 3-5 seconds until a blue/red light is flashing intermittently.
- (D) If the indicator is not flashing, repeat by press & hold for 3~5 seconds until the blue/red indicator is flashing intermittently.

- (E) Enter “0000” when prompted to enter a PIN code.
- (F) Once paired and a connection is made, the Bluetooth Indicator turns blue and flashes intermittently.
- (G) To cancel Bluetooth function, press & hold Bluetooth Power & Indicator for 3 seconds.
- (H) When connecting to another mobile device, power off and on the Bluetooth receiver. Repeat the instructions above to connect a different device. Blue/red light is flashing intermittently indicates the receiver is ready to be paired.
- (I) Pairing Bluetooth for two systems: *Please confirm the version of the two Bluetooth receivers is consistent.
Turn on one system first and operate steps B~F, then turn on the other one and do steps B~E. Press the Bluetooth button twice for each system, during blue/red indicator light flashing intermittently, two Bluetooth receivers are pairing with each other. Once paired, the blue color indicator light will flash intermittently or stay on. Now play the music from the paired smartphone and get stereo sound amplification.

IV. Advanced Operating Instructions

1. Wireless Mic System:

(A) Channel Set-up (UHF models):

- (1) To Scan for a Clear Receiver Channel: Press & hold the SCAN/ACT button  until the current channel blinks. Release the button, blinks will last several times and stop on the current channel. During blinking, press & release the SCAN/ACT button again and the receiver scans and sets at a clear channel automatically. Then the new channel will be stored.

(a) Press & hold

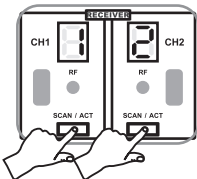

(b) Channel blinks

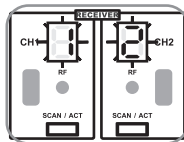

(c) Press again to scan a clear channel automatically

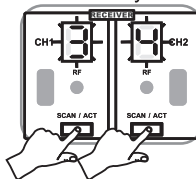

(d) The new channel is stored

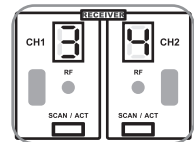

- (2) Manually Forcing a Channel Change: Press & hold the SCAN/ACT button and the current channel blinks. Keep holding the button and this will force the receiver to change to the next available clear channel every two blinks. Release the SCAN/ACT button until the desired channel is reached. Then the new channel will be stored.

(a) Press & hold and the channel blinks

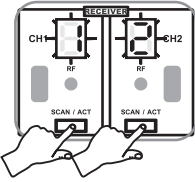

(b) The channel number will change to the next one every two blinks

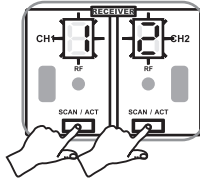

(c) Release until the desired channel

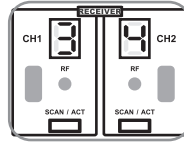

(d) The new channel is stored

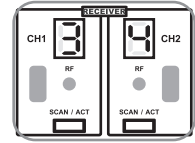

(B) Channel Set-up (ISM models):

- (1) To Scan for a Clear Receiver Channel: Press & hold the SCAN/ACT button **20** until the current channel blinks. Release the button, blinks will last several times and stop on the current channel. During blinking, press & release the SCAN/ACT button again and the receiver scans and sets at a clear channel automatically. Then the new channel will be stored.

(a) Press & hold

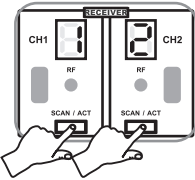

(b) Channel blinks

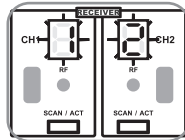

(c) Press again to scan a clean channel automatically

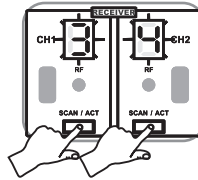

(d) The new channel is stored

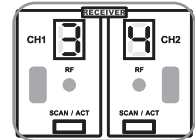

- (2) Manually Forcing a Channel Change: Press & hold the SCAN/ACT button for 1 second and the current channel blinks. Release the button, blinks will last several times and stop on the current channel. Keep holding the button and this will force the receiver to change to the next channel every one blink. Release the SCAN/ACT button until the desired channel is reached. Then the new channel will be stored.

(a) Press & hold

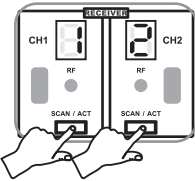

(b) Channel blinks

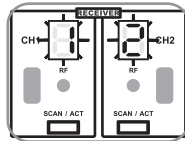

(c) Keep holding the button and the channel will change to the next one every one blink.

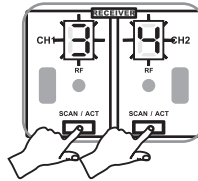

(d) Release until the desired channel and the new channel is stored

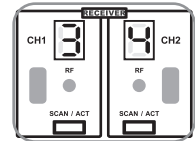

(C) When to Change Channel:

- (1) Interference or malfunction occurs during operation.
- (2) When two or more systems need to be used at the same venue.

(D) Cautions:

- (1) Do not select a new channel while another system is operating as it may cause interference.
- (2) If “_” is displayed during channel scanning this indicates the current channel in this frequency band is experiencing interference. If the problem persists, it is recommended to change and use a different frequency band.

(E) ID (Identification) CODE (ISM models only):

- (1) Setting ID code enables the user to increase compatible channels at the same venue using the same operating channel, especially in a heavily congested Wi-Fi environment and interferences.
- (2) This device has 9 available ID codes: 1→2→3→4→5→6→7→8→P. P is a random ID code.
- (3) Setting ID code:
 - (a) Press & hold the SCAN button. Concurrently, turn on the Power Switch/Wireless Mic Volume Control. Press & release the SCAN button will move up to the next available ID code. Turn off the Power Switch/Wireless Mic Volume Control to save this ID CODE.
 - (b) Turn on the Power Switch/Wireless Mic Volume Control back on again to perform the ACT synchronization with embedded ID code. Without performing this ACT synchronization step, no sound output because the ID codes have been changed even though the same channel number remains the same.

(F) ACT Synchronization (Sync) between Receiver and Transmitter Channels:

- (1) Press and release the SCAN/ACT button, the current channel blinks and is ready for ACT synchronization.
- (2) Power on handheld or bodypack transmitter. Bring the transmitter sync port (red indicator) within 30 cm (12-inch) of CH 1 or CH 2 receiver sync port.
- (3) Once ACT synchronization is done, the channel screen will stop blinking.
- (4) To cancel an accidental activation of the ACT function, just press the SCAN/ACT button again.

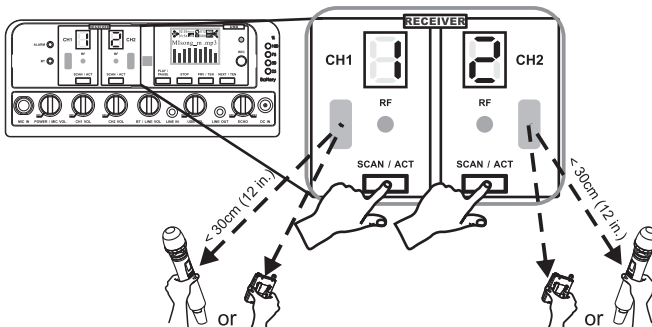

(G) Caution (ISM models):

- (1) Position the personal PA system at least 5-meter away from 5.8 GHz Wi-Fi or other 5.8 GHz transmitting devices.
- (2) Users can scan the surrounding Wi-Fi devices by smartphone Apps and make sure to keep the personal PA system away from these devices.
- (3) Line-of-sight between the transmitter and the personal PA provides the ideal reception range.

2. Music Playback:

(A) USB Display Screen:

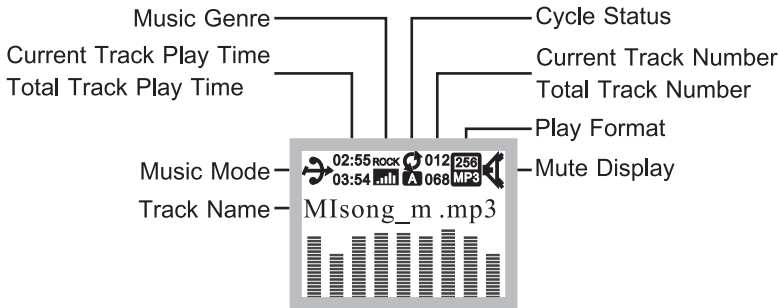

(B) Press PLAY/PAUSE button to pause the track.

(C) USB flash drive is not inserted.

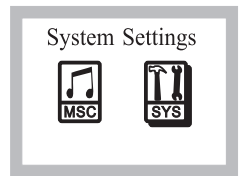
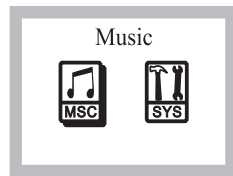
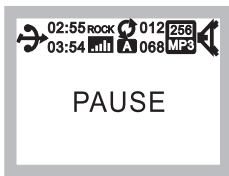

(D) Panel Operating Instructions: During track playing, press & hold the PLAY/PAUSE button to enter music parameter selection for changes. Press the PLAY/PAUSE button and then press PRV/TEN or NEXT/ TEN to locate the desired parameter. Press PLAY/PAUSE to confirm the change and save.

(E) Remote Operating Instructions: During track playing, press the Mode button to enter music parameter selection for change. Press or to highlight selection. Press confirm.

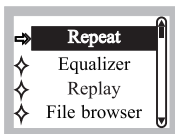

(F) Repeat Mode: Press PRV/TEN ◀◀ or NEXT/TEN ▶▶ to select parameter.

- (1) Repeat All: **A** . (3) Repeat One: **1** .
 (2) Repeat Folder: **D** . (4) Random: **R** .

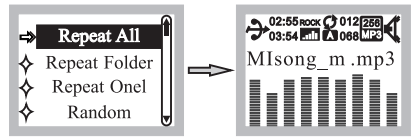

(G) Equalizer Mode:

- (1) Press PRV/TEN ◀◀ or NEXT/TEN ▶▶ to select parameter.
 (2) Press PLAY/PAUSE ⏸ to confirm.
 (3) **NOR** Natural: Normal → **POP** Pop: Popular → **ROCK** Rock: Rock → **JAZZ** Jazz: Jazz →
CLAS Classic: Classical → **SOFT** Soft: Soft → **DBB** DBB: Deep Bass.

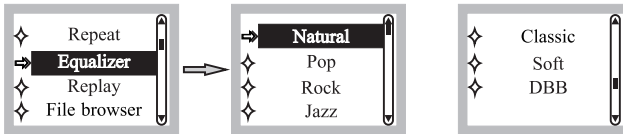

(H) Replay Mode:

- (1) Reply A- / -B mode.
 (2) In Replay Mode, press PLAY/PAUSE ⏸ to enter.
 (3) Press NEXT/TEN ▶▶ to select A- ; press NEXT/TEN ▶▶ again to select -B. Then it will replay A-B.
 (4) Press PLAY/PAUSE ⏸ to stop Replay Mode and return to playback mode.

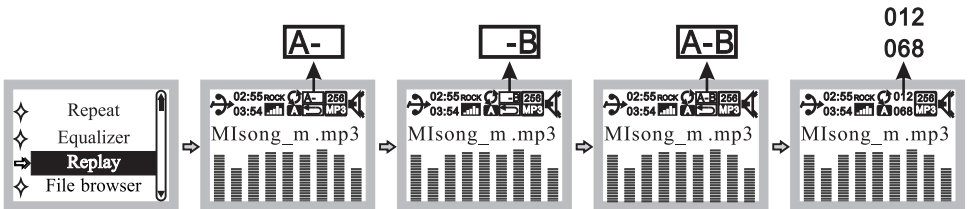

(I) File Browser Mode: Press PLAY/PAUSE ⏸ to enter track directory. Press PRV/TEN ◀◀ or NEXT/TEN ▶▶ to select the desired song. Press PLAY/PAUSE to play the song tracks.

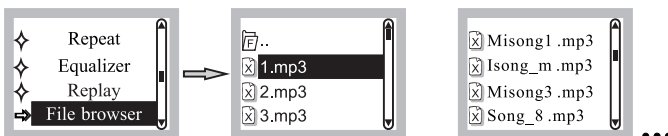

(J) Exit: In the “EXIT” option, press PLAY/PAUSE  to return to the playback mode.

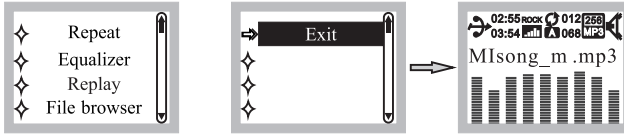



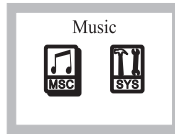

(K) Enter the Main Mode: USB flash drive not inserted or press & hold STOP button during playback.

(1) Music Mode: Insert USB flash drive and press PLAY/PAUSE  to play music.

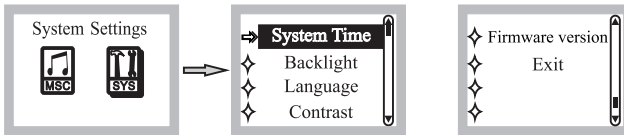

(2) System Settings Mode: Press PRV/TEN  or the NEXT/TEN  to change functions, press PLAY/PAUSE  to confirm and enter system settings.



(3) Date & Time: Press PLAY/PAUSE  to enter the System Time setting mode, press PRV/TEN  or NEXT/TEN  to change. Press PLAY/PAUSE to confirm.

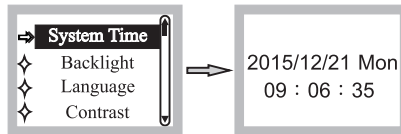

(4) Backlight Brightness Time: 00 is constant. The parameter can be set by an interval of 10 seconds between 00 and 240.

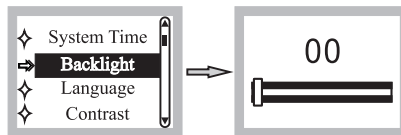

(5) Language



(6) Contrast

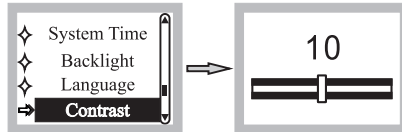

(7) Firmware Version

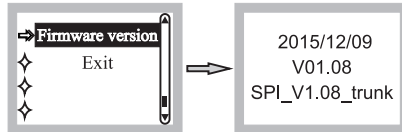

(8) Exit: Return to Music & System Settings (Main Mode).

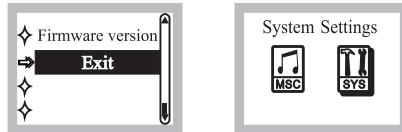

(L) Directory Selection:

- (1) File Browser: Press **⏸** during playback and screen displays PAUSE. Press & hold **⏸** to enter the directory option. Press **⏪** or **⏩** to sequentially select the directory option.

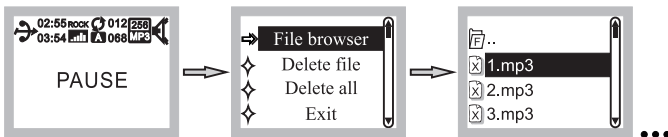

- (2) Delete File: Press **⏸** to enter the "Delete file" screen. Press **⏪** or **⏩** to select "NO" or "YES". Press **⏸** to confirm.

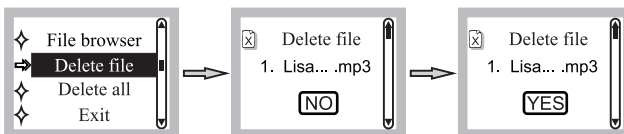

- (3) Delete All: Press **⏏** to enter the “Delete all” screen. Press **⏪** or **⏩** to select “NO” or “YES”. Press **⏏** to confirm.

Caution: Performing this function will delete all files in the flash drive disk. Be careful when using the “Delete” function.

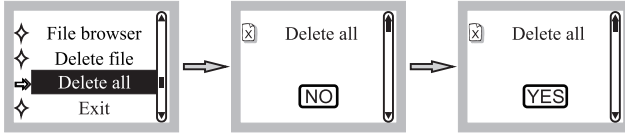

- (4) Select “EXIT” to return to the PAUSE screen. Press **⏏** to return to playback mode.



3. MP3 Player Remote Control:

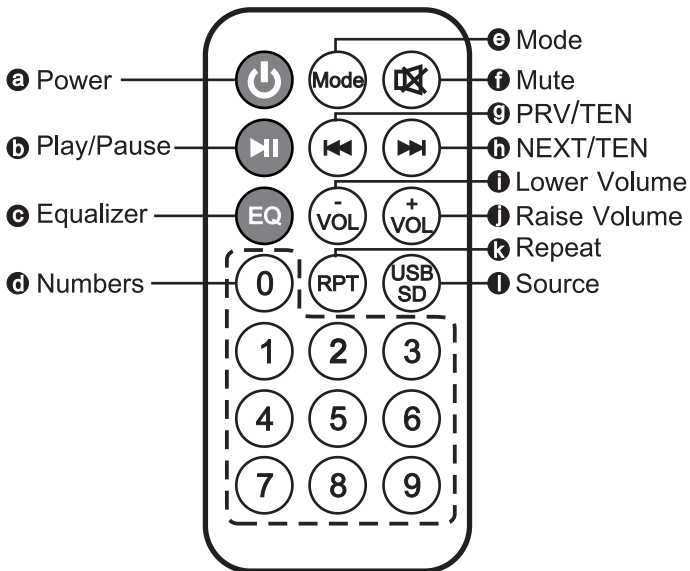

4. Battery Replacement:

- (A) Press and hold the tenon on the bottom of the remote control and then slide out the battery tray.
- (B) Insert a new battery and make sure that the battery's positive (+) side is facing up.
- (C) Slide the battery tray back into the remote control until it clicks.
- (D) The remote control can function at distances of up to 5 meters. The remote control uses a CR 2025 lithium 3V coin battery.

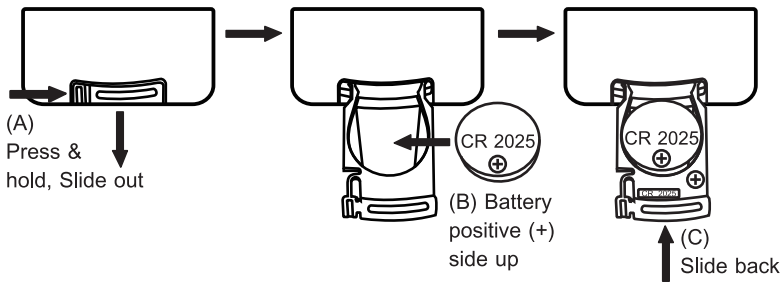

(E) Cautions:

- (1) Do not hit the device.
- (2) Keep away from strong magnetic and electric fields.
- (3) Do not disassemble, repair or remodel by yourself.
- (4) There will be no notice when changes are made due to product improvements.

V. Rechargeable Battery

1. Charging Instructions:

- (A) Charge the battery completely in its first use to obtain its maximum capacity. Connect to any available AC power outlet using the included DC adapter to the DC IN jack.
- (B) The Battery Charging Indicator **7** LED blinks while charging. Blinking LED may start later if the battery suffers from excessive battery drain. The battery may be damaged if the LED does not blink after charging for a while.
- (C) The battery is low when only the red LED is on. Please recharge the battery for at least 4 hours (the time of charging depends on the type of battery).
- (D) All LEDs are blinking indicates the battery is charging. Charging is completed when all LEDs glow.

- (E) Fully charge the battery for storage if it will not be used for an extended period. Batteries may lose some capacity over time. Over-discharged occurs and may damage the battery if not recharged for a long period. Thus, it is recommended to recharge often or every 3 months.
- (F) This device has 2-step automatic power cut-off functions. The battery display will drop to red color for a while during low power status and power will automatically shut off to prevent battery operation. Recharge the battery immediately to avoid damage due to over-discharging.
- (G) Change to a new, fresh battery when battery hours are shortened after recharges due to battery aging.
- (H) Under proper use and charging, the batteries rarely need to be replaced. For a long time operation, spare batteries should be prepared to be replaced at any time. To ensure consistent capacity for ideal operating hours, it is recommended to replace 4 batteries one time.
2. Insert 4 rechargeable batteries according to the polarity. Then put the module into the battery compartment after the connecting terminal is connected.
 3. 4 LEDs on the panel of the battery slots indicate the battery's incorrect polarity, and the LED number is for users to easily identify which battery slot detects incorrect polarity. If the LED glows and stays on, the corresponding battery will discharge with little current. After a long time, that battery will be over-discharged.
 4. The batteries have been paired with voltage and impedance to prevent imbalance after long-term use.

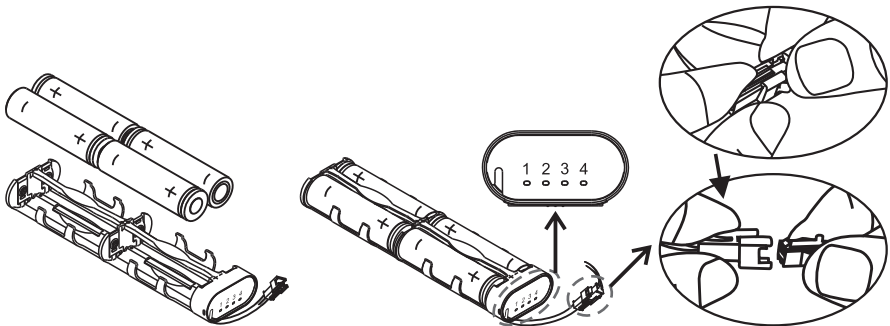

5. MA-100/MA-200 Battery Module Replacement:

- (A) Lay the PA system on a flat surface. Remove the USB disk. Remove the battery compartment cover by push the release button **ⓑ** to the OPEN position.
- (B) Pull out the battery module and replace new batteries according to Step 2. Then insert the module into the battery compartment.
- (C) Before putting back the battery compartment cover, pull the shoulder belt into the trough on the cover.

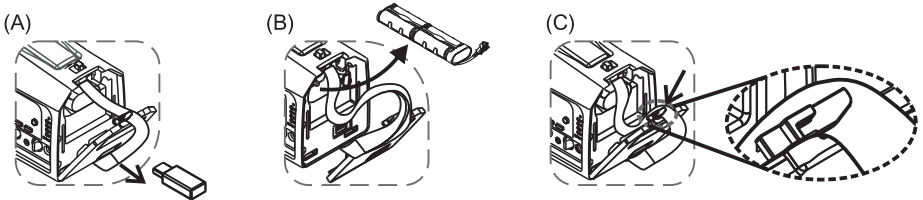

- (D) Push the release button **ⓑ** to the OPEN position, push back the compartment cover, and then push the release button back to secure the cover. Ensure the cover is secured.

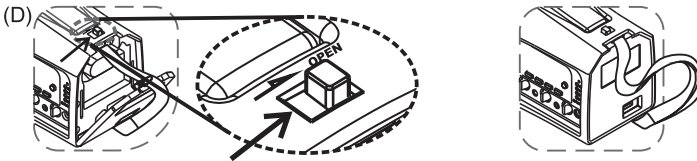

6. MA-300 Battery Module Replacement:

- (A) Lay the PA system on a flat surface. Detach the screws to open the battery compartment cover.
- (B) Pull out the battery module and replace new batteries according to Step 2. Then insert the module into the battery compartment.
- (C) Put back the battery compartment cover by confirming the hooks of the cover are going inside the trough of the battery compartment. Then screw the cover.

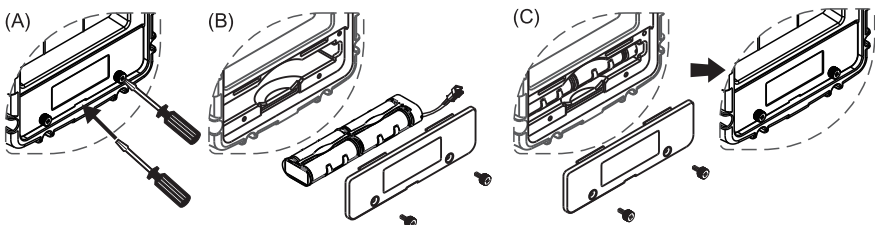

VI. Connection to External Audio Sources

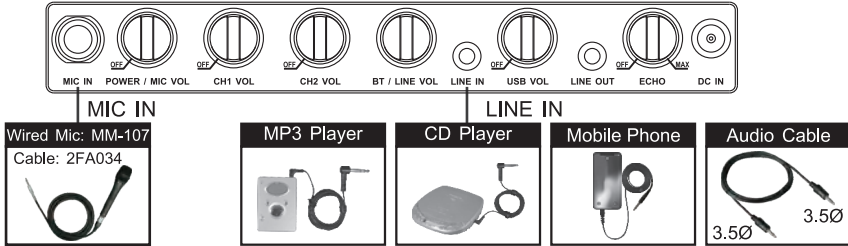

VII. Others

1. Can be hand-carried, put on a microphone tripod, or MIPRO MS-90 wall-mounting kit. MA-100/MA-200 can be shoulder carried.
2. Simply pull up the built-in carry handle for hand carry. The carry handle has a spring control device for storing the handle and to prevent spring fatigue.



Installed on a tripod

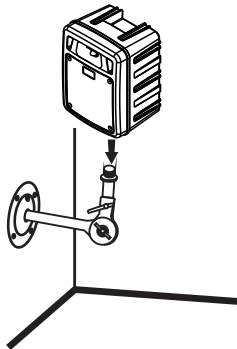

Installed on a wall-mounting kit

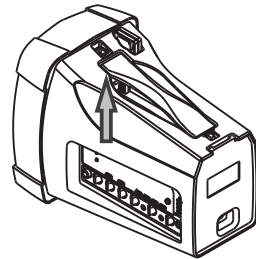

Built-in carry handle

3. MA-300 USB Drive Operation

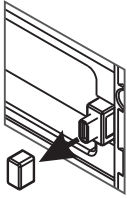

(A) Pull out the USB port to a 90-degree angle. Remove the protective cap.

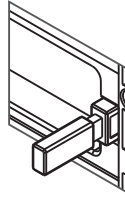

(C) Ensure the USB drive is plugged firmly and securely.

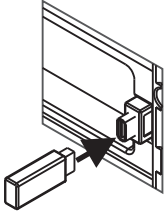

(B) Insert a Type-A USB drive (USB interface).

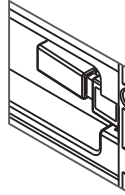

(D) Push back the USB port into the standard position to prevent accidental issues.

VIII. Note

1. Design and specifications are subject to change without prior notice. Refer to the actual product in the event of product discrepancy.
2. Frequency range, output power and maximum deviation to adhere to local telecom regulations.

MIPRO[®]
MICROPHONE PROFESSIONALS

MIPRO Electronics Co., Ltd

Headquarters: No. 814, Beigang Rd., Chiayi City 600079, Taiwan
Tel : +886.5.238.0809
www.mipro.com.tw

Fax : +886.5.238.0803
mipro@mipro.com.tw



All rights reserved. YM 022/02

Do not copy or forward without prior approvals of MIPRO.
Specifications and design subject to change without notice.



2 CE672B