

MIPRO[®] ACT-24R

2.4 GHz Digital Wireless Receiver

User Guide

FOR AVLEX ONLY



MIPRO[®]
MICROPHONE PROFESSIONALS

MIPRO Electronics Co., Ltd
Headquarters : 814 Pei-Kang Road, Chiayi, 60096, Taiwan
Tel : +886.5.238.0809 Fax : +886.5.238.0803
www.mipro.com.tw mipro@mipro.com.tw

All rights reserved. MN 017/08

Do not copy or forward without prior approvals MIPRO.

Specifications and design subject to change without notice.

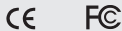

2CE597A

Contents

- 1 Controls and Indicators
- 3 Operating Instructions
- 6 Display - Shows receiver settings
- 11 ACT Synchronization (sync)
- 13 Cautions & Recommendations
- 15 Installations & Applications
- 17 MP-80 Battery Charger (Optional)
- 18 MP-20 Dual-Slot Battery Charger (Optional)
- 19 AF Output Connections

Controls and Indicators

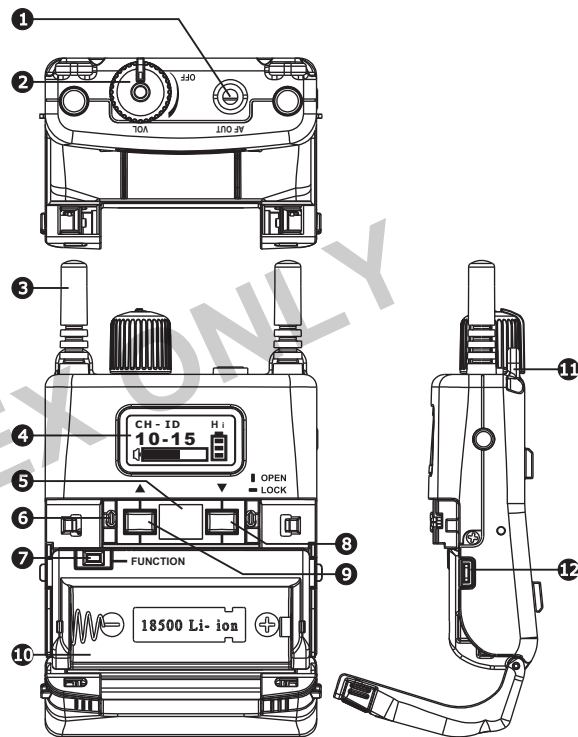

- 1 Audio Out 3.5mm Jack:** Insert earphones or headphones here.
- 2 Power & Volume Control:** Power on and off with volume adjustment.
- 3 Receiving Antenna**
- 4 LCD Display Screen with backlight**

- 5 **ACT sync window:** frequency synchronization with a transmitter via infrared interface.
- 6 **Lockable Catches:** Adjust to lock or open battery compartment cover.
- 7 **Function button:** channel changing only or parameter setting and performing sync.
- 8 **"▼" Arrow Down or ACT sync/setting parameter button**
- 9 **"▲" Arrow Up or Mode selection button**
- 10 **Battery Compartment:** Insert one rechargeable 18500 lithium battery.
- 11 **Lanyard hooks**
- 12 **Charging contacts**

Operating Instructions

1. Battery Replacement

- a. A Locked Latch (horizontal position).
Battery compartment cover cannot be opened.
- b. An Open Latch (vertical position).
Battery compartment cover can be opened.
- c. Ascertain both latches are in vertical position. Press and hold side latches to open battery compartment cover. (diagram 1)
- d. Insert one 18500 battery properly with correct polarity, and close the cover. (diagram 2)
- e. Ascertain both latches are in horizontal positions to ensure the battery compartment cover is tightly secured and cannot be opened.

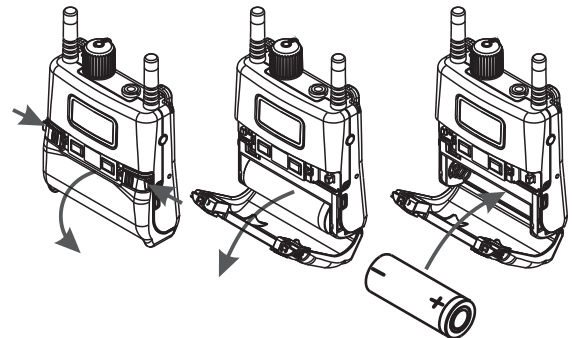
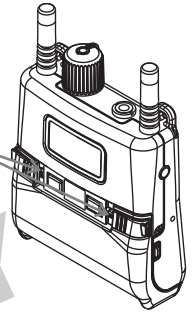

(diagram 1)

(diagram 2)

Caution

Do preserve battery life by switching off a device and removing the batteries when it's not being used, and is not expected to be used for extended periods of time.

2. 3.5mm Earphones Jack

a. Insert and connect earphones (not included) to the headphone jack on the receiver.

b. Caution:

Ascertain to use a stereo earphones or headphones. A mono, non-stereo earphones may not work properly.

Warning: Avoiding Hearing Damage –

Permanent noise-induced hearing loss may occur on prolonged exposure to loud sounds wearing earphones or headphones.

We recommend you listen responsibly by limiting the amount of time that you use earphones or headphones at high volume.



To prevent possible hearing damage, do not listen at high volume levels for long periods.

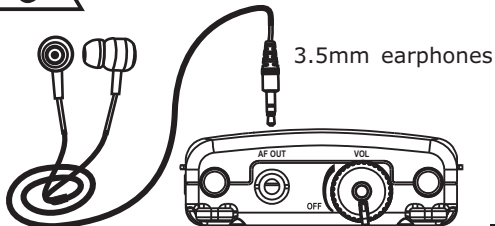

3. Power On/Off & Volume Control

- The backlit light will dim automatically after the device is powered on to conserve battery life.
- Slowly turn up the volume to a comfortable, safe sound level. Power off the device when not in use to conserve battery life.

* see Warning to avoid hearing damage.

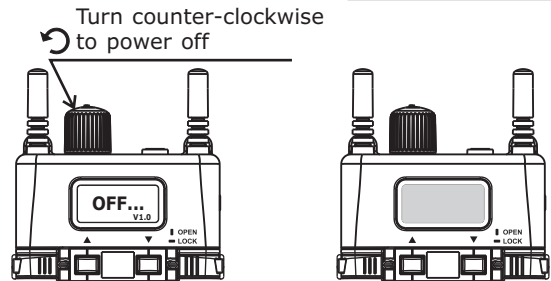
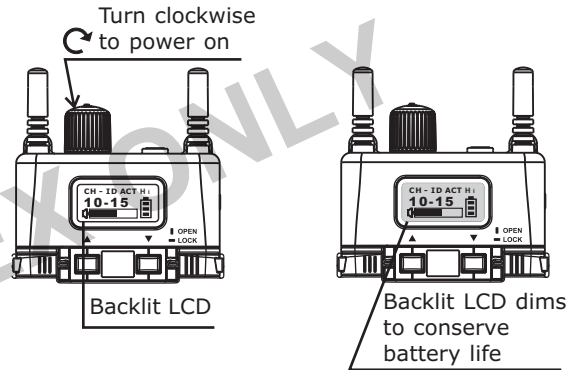

Caution: Device will not power on with insufficient power. Insert a fully-charged rechargeable battery. Once the device has sufficient power, it can be powered on.

Display - Shows receiver settings

1. FUNCTION button -

Press FUNCTION button to enter the "ACT" or no "ACT" screen.

Mode button -

Purpose of the MODE button (with appearing ACT icon) is to access function sequence for changing the parameter value.

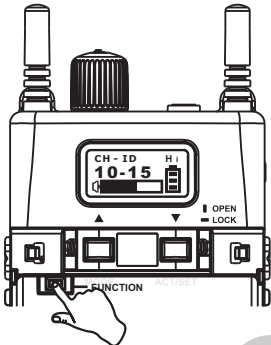

Press and hold FUNCTION button until the ACT icon disappears

No "ACT" icon indicates receiver settings cannot be changed and sync cannot be performed. The only function available is changing the channel numbers.

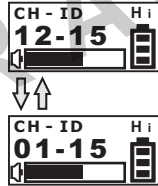

- Ascertain both latches are in vertical position. Press and hold side latches to open battery compartment cover.
- Press and hold FUNCTION button until screen blinks and "ACT" icon disappears. Channel numbers can be changed by pressing the ▲ or ▼ button.
- Channels 1 – 12 are selectable.

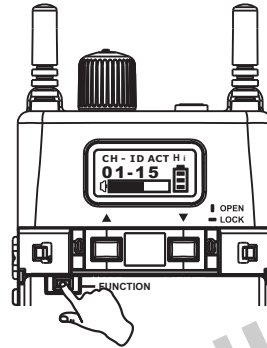

Press and hold FUNCTION button until the ACT icon appears

If "ACT" icon appears it indicates receiver settings can be changed and sync can be performed

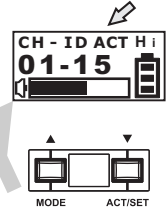

- Once ACT icon appears, pressing the MODE (▲) button & ACT/SET (▼) button allow changes to parameter setting.
- Functions Sequence in MODE.

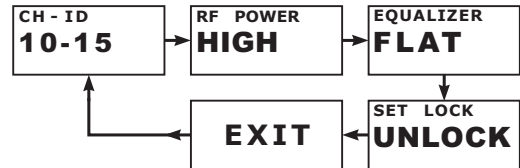

- Parameter setting changes by pressing ACT/SET button.

2. Parameter Settings

(1) CH-ID = Channel & ID Code

Channel setting:

- Press and release MODE (▲) button until it stops at CH-ID screen. Press & release ACT/SET (▼) button until number cursor below CH is blinking.
- During blinking, press ACT/SET (▼) button to change the parameter. Setting auto saves when MODE (▲) button is pressed or blinking stops.

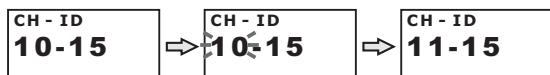

ID Code setting:

- Press and release MODE (▲) button until it stops at CH-ID screen. Press & release ACT/SET (▼) button and then MODE (▲) button until number cursor below ID is blinking.
- During blinking, press ACT/SET (▼) button to change the parameter. Setting auto saves when MODE (▲) button is pressed or blinking stops.

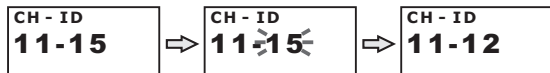

(2) RF POWER Setting

- Press and release MODE (▲) button until it stops at RF POWER screen. Press & release ACT/SET (▼) button until HIGH or LOW cursor is blinking.
- HIGH or LOW selectable.
- Setting auto saves when MODE (▲) button is pressed or blinking stops.
- RF Power setting can be transmitted and synced with a transmitter by pressing the ACT/SET button when all settings are changed.

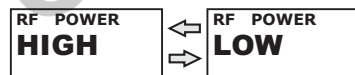

(3) EQUALIZER Setting

- Press and release MODE (▲) button until it stops at EQUALIZER screen. Press & release ACT/SET (▼) button until FLAT or L-CUT cursor is blinking.
- FLAT or L-CUT selectable.
- Setting auto saves when MODE (▲) button is pressed or blinking stops.

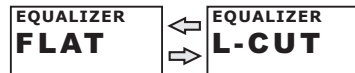

(4) SET LOCK Setting

- Press and release MODE (▲) button until it stops at SET LOCK screen. Press & release ACT/SET (▼) button until UNLOCK or LOCK cursor is blinking.
- UNLOCK or LOCK selectable.
- UNLOCK: buttons are unlocked and can be changed. LOCK: buttons are locked and cannot be changed.
- Setting auto saves when MODE (▲) button is pressed or blinking stops.
- During locked setting, all other parameter settings cannot be changed.



(5) EXIT

- Press and release MODE (▲) button until it stops at EXIT screen.
- Press & release ACT/SET (▼) button will auto saves all setting changes and return to main screen.

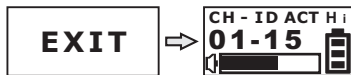

(6) Battery Level Indicator

Lithium-ion (Li-ion) rechargeable batteries don't suffer the memory effect. Do not charge them until it has zero level. We recommend charging once battery level falls to one level. Device will activate a shutdown, "OFF" word appears, if voltage hits a certain low voltage level. Once the battery is recharged it can be powered on again. Rechargeable batteries have a limited number of charge cycles and may eventually need to be replaced.



ACT Synchronization (sync)

NOTE: during a successful synchronization between the receiver and transmitter, Channel, ID Code and RF Power parameter values, are transmitted.

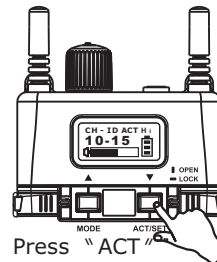

Press "ACT" button to Sync

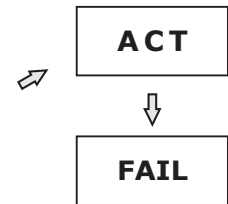

FAIL appears during a failed synchronization

- (1) On the LCD display, briefly press "ACT" button. "ACT" appears on the display.
- (2) Place the transmitter within 10cm of the receiver, and position the ACT signal indicator of the transmitter toward the "IR" area on the receiver panel. See below.
- (3) The ACT function will be deactivated automatically once the microphone channel is locked on and the LCD display on the receiver module returns to the home screen. If "FAIL" is appeared on the display, the function was not successful and will have to repeated.

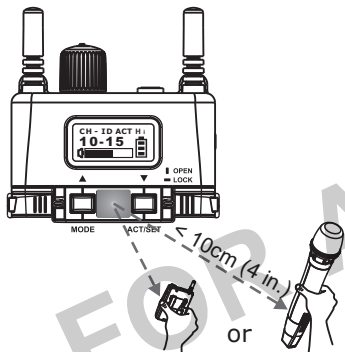

Sync Transmitter and Receiver

Cautions & Recommendations

1. Position the receiver at least 5-meter away from WiFi, Bluetooth or other 2.4 GHz transmitting devices.
2. Line-of-sight provides the ideal reception range between the transmitter and receiver.
3. **User can scan environment for WiFi devices with smartphone app, normally WiFi channel selections are 1, 6, 11.**
 - a. **When there is WiFi channel selection 1, receiver channels can be set at 01 and 10 for non-interfering channels. Or select a lesser interference channels like 02, 03, 04, 05, 06, 07, 08, 09.**
 - b. **When there is WiFi channel selection 6, receiver channels can be set at 01 and 11 for non-interfering channels. Or select a lesser interference channels like 02, 03, 04, 05, 06, 07.**
 - c. **When there is WiFi channel selection 11, receiver channels can be set at 01 and 12 for non-interfering channels. Or select a lesser interference channels like 02, 03, 04, 05, 06, 07, 08, 09.**

4. Wi-Fi Channel Distribution:

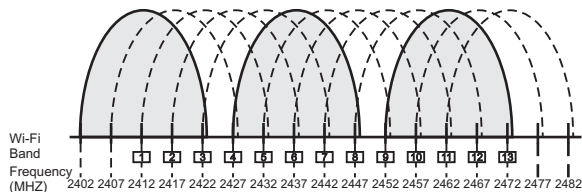

- Using different impedance earphones, different battery types, high monitoring volume, cold/high temperature and higher gain settings may cause the receiver battery life to be different than specified. Earphones with sensitivity over 110dB/mW are recommended.

Installations & Applications

- Can be worn around the neck with a supplied lanyard. Tour-guide or language translation application.

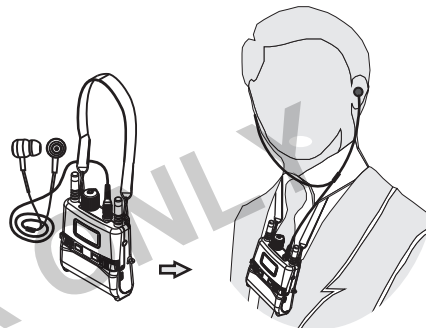

- Bodpack Clip (optional)

Can be worn right side up or upside down.

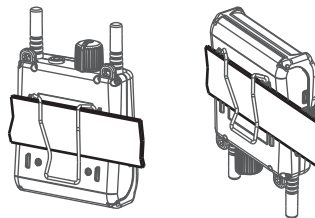

3. Camera Shoe Mount (optional)

Can be mounted to a small to medium size camcorder.

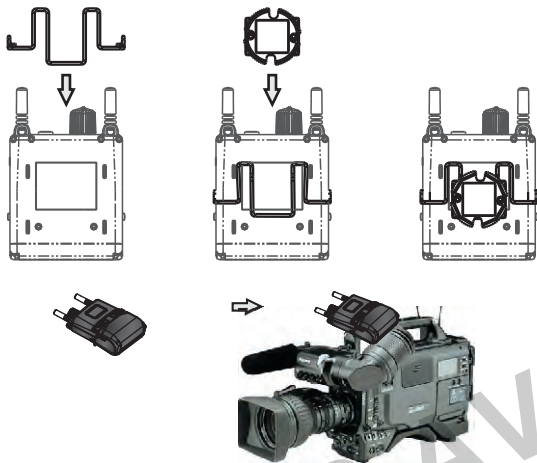
**MP-80 Battery Charger (Optional)**

MP-80 Charger charges both Receivers and 18500 rechargeable batteries.

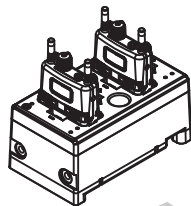

Receivers Charging

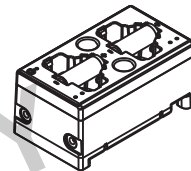

18500 Charging

MP-20 Dual-Slot Battery Charger (Optional)

Use the Battery Charger to charge up to two rechargeable 18500 Li-ion batteries for rechargeable MIPRO handheld or bodypack transmitter.

Charging Batteries: Insert the batteries with the correct positive (+) & negative (-) polarity and plug the charger into a power outlet, as shown here.

Charge Status: The indicator light displays the charging status of the batteries.

- Still Red: The batteries are charging.
- Still Green: The batteries are charged and ready to use.
- Flashing Light: May indicate any of the following conditions:
 - a. The batteries haven't been properly installed in the charger.
 - b. An unsupported type of battery is in the charger.
 - c. The batteries may be faulty or damaged and should be replaced.

Rechargeable 18500 Li-ion Batteries

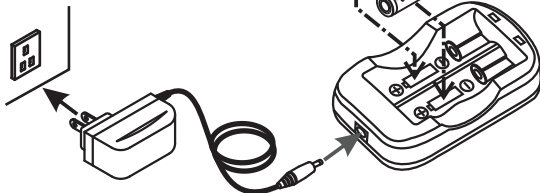

(Transformer is shown here for reference only)

AF Output Connections

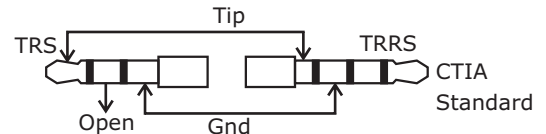
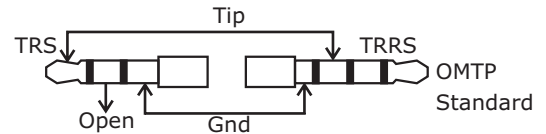
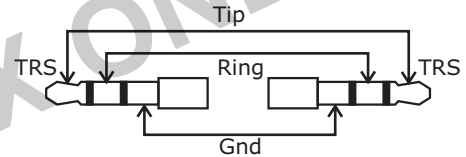
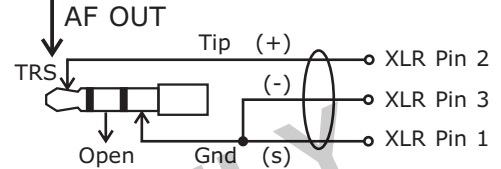
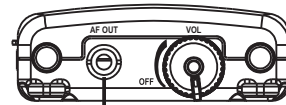

Federal Communication Commission Interference Statement

This equipment has been tested and found to comply with the limits for a Class B digital device, pursuant to Part 15 of the FCC Rules. These limits are designed to provide reasonable protection against harmful interference in a residential installation. This equipment generates, uses and can radiate radio frequency energy and, if not installed and used in accordance with the instructions, may cause harmful interference to radio communications. However, there is no guarantee that interference will not occur in a particular installation. If this equipment does cause harmful interference to radio or television reception, which can be determined by turning the equipment off and on, the user is encouraged to try to correct the interference by one of the following measures:

- Reorient or relocate the receiving antenna.
- Increase the separation between the equipment and receiver.
- Connect the equipment into an outlet on a circuit different from that to which the receiver is connected.
- Consult the dealer or an experienced radio/TV technician for help.

FCC Caution: To assure continued compliance, any changes or modifications not expressly approved by the party responsible for compliance could void the user's authority to operate this equipment. (Example - use only shielded interface cables when connecting to computer or peripheral devices).

FCC Radiation Exposure Statement

This equipment complies with FCC RF radiation exposure limits set forth for an uncontrolled environment. This equipment should be installed and operated with a minimum distance of 0.5 cm between the radiator and your body.

This transmitter must not be co-located or operating in conjunction with any other antenna or transmitter.

The antennas used for this transmitter must be installed to provide a separation distance of at least 0.5 cm from all persons and must not be co-located or operating in conjunction with any other antenna or transmitter.

This device complies with Part 15 of the FCC Rules.

Operation is subject to the following two conditions:

- (1) This device may not cause harmful interference, and
- (2) This device must accept any interference received, including interference that may cause undesired operation.

IC

This device complies with Industry Canada RSS-210

ISSUE 2 standards. Operation is subject to the following two conditions:

- (1) this device may not cause interference, and
- (2) this device must accept any interference, including interference that may cause undesired operation of the device.

Le présent appareil est conforme aux CNR d'Industrie Canada applicables aux appareils radio exempts de licence.

L'exploitation est autorisée aux deux conditions suivantes:

- (1) l'appareil ne doit pas produire de brouillage, et
- (2) l'utilisateur de l'appareil doit accepter tout brouillage radioélectrique subi, même si le brouillage est susceptible d'en compromettre le fonctionnement.

Notes

1. Refer to actual product in the event of product description discrepancy.
2. Frequency range and maximum deviation comply with the regulations of different countries.

WARNING**1. FOR OUTDOOR USE:**



To reduce the risk of fire or electric shock, do not expose this apparatus to rain or moisture.

2. UNDER WET LOCATION:

Apparatus should not be exposed to dripping or splashing and no objects filled with liquids, such as vases should be placed on the apparatus.

3. SERVICE INSTRUCTIONS:

CAUTION - These servicing instructions are for use by qualified service personnel only. To reduce the risk of electric shock, do not perform any servicing other than that contained in the operating instructions unless you are qualified to do so.

CAUTION

RISK OF ELECTRIC SHOCK
DO NOT OPEN

 This symbol indicates that dangerous voltage constituting a risk of electric shock is present within this unit.

 This symbol indicates that there are important operating and maintenance instructions in the literature accompanying this unit.

Disposal Dispose of any unusable devices or batteries responsibly and in accordance with any applicable regulations.



Disposing of used batteries with domestic waste is to be avoided!

2005-08-18

Batteries / NiCad cells often contain heavy metals such as cadmium(Cd), mercury(Hg) and lead(Pb) that makes them unsuitable for disposal with domestic waste. You may return spent batteries/accumulators free of charge to recycling centres or anywhere else batteries/accumulators are sold.

By doing so, you contribute to the conservation of our environment!